







Assembly code	Assembly description	Assembly image
ASM3199A/0.D03	Cooking chamber	
ASM3226A/0.D06	External cover	
ASM3238A/0.D02	Electrical system	
ASM3244A/0.D01	Electrical system	
ASM3274A/0.D00	Door	



ASM3199A/0.D03 - Cooking chamber

FRONT

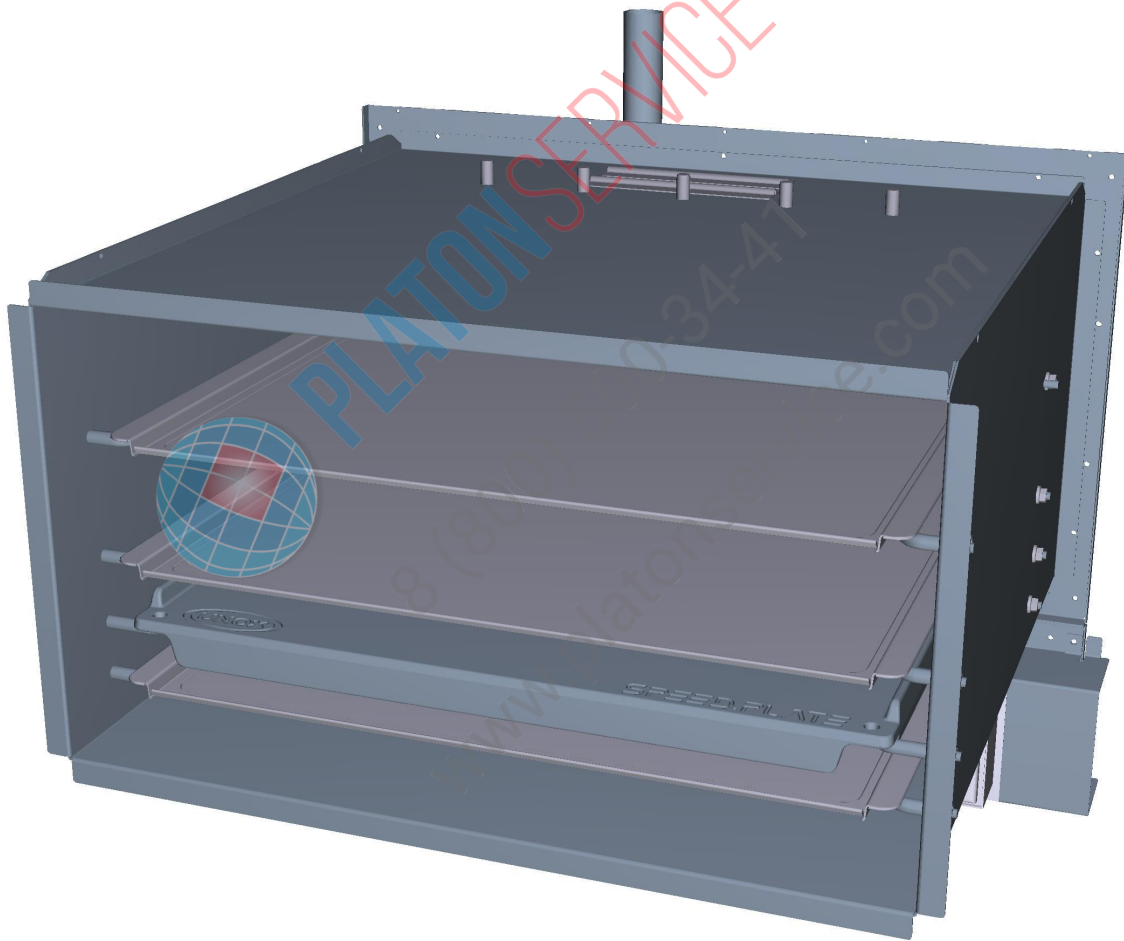



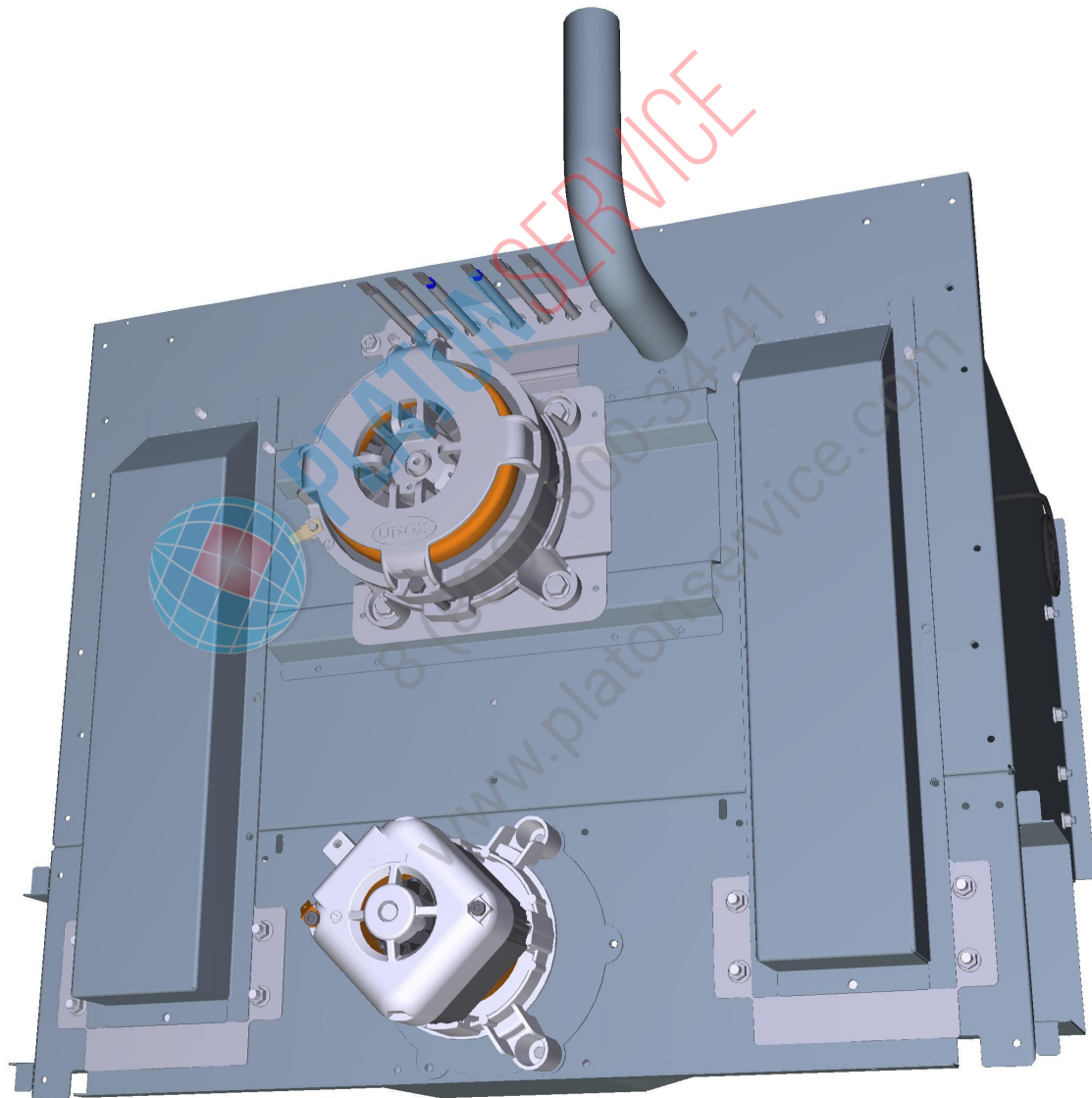

ASM3199A/0.D03 - Cooking chamber

REAR



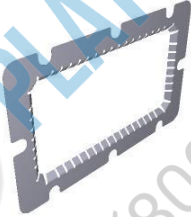

COMPONENT			SPARE PART		
Code	Description	Image	Code	Description	Kit components
0G1076A	MW FAN GUARD		0G1076A1	MW FAN GUARD	
0H3067A	0H3067A0		0H3067A0	0H3067A0	
0H3068A	SPEED.PRO GUIDE EMI GASKET		0H3068A0	SPEED.PRO GUIDE EMI GASKET	
0H5252A	0H5252A1		0H5252A1	0H5252A1	
0H5253B	MW GUIDE PTFE GASKET COVER		0H5253B0	MW GUIDE PTFE GASKET COVER	



COMPONENT			SPARE PART																						
Code	Description	Image	Code	Description	Kit components																				
0H5280A	MW HEATING ELEMENT PLATE		0H5280A0	MW HEATING ELEMENT PLATE																					
0H3020A	MOTOR SHAFT SEALING DISC		0H3020A1	MOTOR SHAFT SEALING DISC																					
0H5245A	MW MOTOR GLASS WOLL PUSHING PLATE		0H5245A1	MW MOTOR GLASS WOLL PUSHING PLATE																					
GN1547A	SHAFT GASKET D11.8		KGN1547A	D11.6 MOTOR SHAFT GASKET 3PCS KIT	<table border="1"> <thead> <tr> <th>Code</th> <th>Description</th> <th>Qty</th> <th>UOM</th> </tr> </thead> <tbody> <tr> <td>GN1547A1</td> <td>SHAFT GASKET D11.8</td> <td>3.000</td> <td>PC</td> </tr> </tbody> </table>	Code	Description	Qty	UOM	GN1547A1	SHAFT GASKET D11.8	3.000	PC												
Code	Description	Qty	UOM																						
GN1547A1	SHAFT GASKET D11.8	3.000	PC																						
MT1012A	330W 230V MOTOR		KVN1130A	LUX ≤08.2017/L.MISS/S.5/ 5E MOTOR KIT	<table border="1"> <thead> <tr> <th>Code</th> <th>Description</th> <th>Qty</th> <th>UOM</th> </tr> </thead> <tbody> <tr> <td>0H4305A1</td> <td>ST. STEEL MOTOR SHAFT SEALING DISC</td> <td>1.000</td> <td>PC</td> </tr> <tr> <td>GN1140A3</td> <td>MOLDED MOTOR HOLDER GASKET</td> <td>1.000</td> <td>PC</td> </tr> <tr> <td>VI1045A0</td> <td>16x8,4 Th=1,6 ST.STEEL WASHER</td> <td>1.000</td> <td>PC</td> </tr> <tr> <td>VI1256A0</td> <td>M8 DIN 980M ST. STEEL SELF LOCKING NUT</td> <td>1.000</td> <td>PC</td> </tr> </tbody> </table>	Code	Description	Qty	UOM	0H4305A1	ST. STEEL MOTOR SHAFT SEALING DISC	1.000	PC	GN1140A3	MOLDED MOTOR HOLDER GASKET	1.000	PC	VI1045A0	16x8,4 Th=1,6 ST.STEEL WASHER	1.000	PC	VI1256A0	M8 DIN 980M ST. STEEL SELF LOCKING NUT	1.000	PC
Code	Description	Qty	UOM																						
0H4305A1	ST. STEEL MOTOR SHAFT SEALING DISC	1.000	PC																						
GN1140A3	MOLDED MOTOR HOLDER GASKET	1.000	PC																						
VI1045A0	16x8,4 Th=1,6 ST.STEEL WASHER	1.000	PC																						
VI1256A0	M8 DIN 980M ST. STEEL SELF LOCKING NUT	1.000	PC																						



COMPONENT			SPARE PART																																							
Code	Description	Image	Code	Description	Kit components																																					
MT1012A	330W 230V MOTOR		KVN1130A	LUX ≤08.2017/L.MISS/S.5/ 5E MOTOR KIT	<table border="1"> <thead> <tr> <th>Code</th> <th>Description</th> <th>Qty</th> <th>UOM</th> </tr> </thead> <tbody> <tr> <td>VM2196A0</td> <td>MOTOR NUT FASTENING BUSHING</td> <td>1.000</td> <td>PC</td> </tr> <tr> <td>VN1130A1</td> <td>330W 230V 50/60HZ MOTO</td> <td>1.000</td> <td>PC</td> </tr> </tbody> </table>	Code	Description	Qty	UOM	VM2196A0	MOTOR NUT FASTENING BUSHING	1.000	PC	VN1130A1	330W 230V 50/60HZ MOTO	1.000	PC																									
			Code	Description	Qty	UOM																																				
VM2196A0	MOTOR NUT FASTENING BUSHING	1.000	PC																																							
VN1130A1	330W 230V 50/60HZ MOTO	1.000	PC																																							
KMT1012A	MIND.MAPS / LUX >08.2017 330W MOTOR KIT	<table border="1"> <thead> <tr> <th>Code</th> <th>Description</th> <th>Qty</th> <th>UOM</th> </tr> </thead> <tbody> <tr> <td>0H2842A0</td> <td>MT1012 CENTERING JI</td> <td>1.000</td> <td>PC</td> </tr> <tr> <td>0H4305A1</td> <td>ST. STEEL MOTOR SHAFT SEALING DISC</td> <td>1.000</td> <td>PC</td> </tr> <tr> <td>GN1140A3</td> <td>MOLDED MOTOR HOLDER GASKET</td> <td>1.000</td> <td>PC</td> </tr> <tr> <td>MT1012A0</td> <td>330W 230V MOTOR</td> <td>1.000</td> <td>PC</td> </tr> <tr> <td>VE1550A0</td> <td>5X3 MM NEODYMIUM MAGNET</td> <td>1.000</td> <td>PC</td> </tr> <tr> <td>VI1077A1</td> <td>SCREW M6x12 TE INOX</td> <td>1.000</td> <td>PC</td> </tr> <tr> <td>VI1521A0</td> <td>STAINLESS STEEL WASHER D=6 6592</td> <td>1.000</td> <td>PC</td> </tr> <tr> <td>VI1966A0</td> <td>M4X14 FLATHEAD SCREW</td> <td>1.000</td> <td>PC</td> </tr> <tr> <td>VM1635A0</td> <td>MAGNET HOLDING DIS</td> <td>1.000</td> <td>PC</td> </tr> </tbody> </table>	Code	Description	Qty	UOM	0H2842A0	MT1012 CENTERING JI	1.000	PC	0H4305A1	ST. STEEL MOTOR SHAFT SEALING DISC	1.000	PC	GN1140A3	MOLDED MOTOR HOLDER GASKET	1.000	PC	MT1012A0	330W 230V MOTOR	1.000	PC	VE1550A0	5X3 MM NEODYMIUM MAGNET	1.000	PC	VI1077A1	SCREW M6x12 TE INOX	1.000	PC	VI1521A0	STAINLESS STEEL WASHER D=6 6592	1.000	PC	VI1966A0	M4X14 FLATHEAD SCREW	1.000	PC	VM1635A0	MAGNET HOLDING DIS	1.000	PC
Code	Description	Qty	UOM																																							
0H2842A0	MT1012 CENTERING JI	1.000	PC																																							
0H4305A1	ST. STEEL MOTOR SHAFT SEALING DISC	1.000	PC																																							
GN1140A3	MOLDED MOTOR HOLDER GASKET	1.000	PC																																							
MT1012A0	330W 230V MOTOR	1.000	PC																																							
VE1550A0	5X3 MM NEODYMIUM MAGNET	1.000	PC																																							
VI1077A1	SCREW M6x12 TE INOX	1.000	PC																																							
VI1521A0	STAINLESS STEEL WASHER D=6 6592	1.000	PC																																							
VI1966A0	M4X14 FLATHEAD SCREW	1.000	PC																																							
VM1635A0	MAGNET HOLDING DIS	1.000	PC																																							
VM1462C	VM1462C0		VM1462C0	VM1462C0																																						
VN1171A	D195 H60 8 BLADES FAN		KVN1171A	D195 H60 8 BLADES M8 NUT FAN KIT	<table border="1"> <thead> <tr> <th>Code</th> <th>Description</th> <th>Qty</th> <th>UOM</th> </tr> </thead> <tbody> <tr> <td>VI1077A1</td> <td>SCREW M6x12 TE INOX</td> <td>1.000</td> <td>PC</td> </tr> <tr> <td>VI1521A0</td> <td>STAINLESS STEEL WASHER D=6 6592</td> <td>1.000</td> <td>PC</td> </tr> <tr> <td>VN1171A0</td> <td>D195 H60 8 BLADES FAN</td> <td>1.000</td> <td>PC</td> </tr> </tbody> </table>	Code	Description	Qty	UOM	VI1077A1	SCREW M6x12 TE INOX	1.000	PC	VI1521A0	STAINLESS STEEL WASHER D=6 6592	1.000	PC	VN1171A0	D195 H60 8 BLADES FAN	1.000	PC																					
					Code	Description	Qty	UOM																																		
					VI1077A1	SCREW M6x12 TE INOX	1.000	PC																																		
VI1521A0	STAINLESS STEEL WASHER D=6 6592	1.000	PC																																							
VN1171A0	D195 H60 8 BLADES FAN	1.000	PC																																							



COMPONENT			SPARE PART																														
Code	Description	Image	Code	Description	Kit components																												
VM1441A	VM1441A1		VM1441A1	VM1441A1																													
VM1442A	VM1442A1		VM1442A1	VM1442A1																													
OH5246A	OH5246A1		OH5246A1	OH5246A1																													
VI1110A	AUTOBLOCKING NUT STAINLESS STEEL		VI1110A0	AUTOBLOCKING NUT STAINLESS STEEL																													
VN1035B	LINE MISS 230 VAC MOTOR		KVN1035B	LINEMISS / LINEMICRO MOTOR KIT	<table border="1"> <thead> <tr> <th>Code</th> <th>Description</th> <th>Qty</th> <th>UOM</th> </tr> </thead> <tbody> <tr> <td>GN1270A0</td> <td>13x5.5x0.8 FLAT WASHER</td> <td>3.000</td> <td>PC</td> </tr> <tr> <td>GN1546A0</td> <td>SHAFT GASKET D8</td> <td>1.000</td> <td>PC</td> </tr> <tr> <td>VI1695A0</td> <td>M6x16 H6 CH10 STAINLESS STEEL NUT</td> <td>1.000</td> <td>PC</td> </tr> <tr> <td>VI1700A0</td> <td>18x6.4x1.5 STAINLESS STEEL FLAT WASHER</td> <td>1.000</td> <td>PC</td> </tr> <tr> <td>VI1836A0</td> <td>M6x12 OT63 ROTOR SCRE</td> <td>3.000</td> <td>PC</td> </tr> <tr> <td>VN1035B1</td> <td>LINE MISS 230 VAC MOTOR</td> <td>1.000</td> <td>PC</td> </tr> </tbody> </table>	Code	Description	Qty	UOM	GN1270A0	13x5.5x0.8 FLAT WASHER	3.000	PC	GN1546A0	SHAFT GASKET D8	1.000	PC	VI1695A0	M6x16 H6 CH10 STAINLESS STEEL NUT	1.000	PC	VI1700A0	18x6.4x1.5 STAINLESS STEEL FLAT WASHER	1.000	PC	VI1836A0	M6x12 OT63 ROTOR SCRE	3.000	PC	VN1035B1	LINE MISS 230 VAC MOTOR	1.000	PC
Code	Description	Qty	UOM																														
GN1270A0	13x5.5x0.8 FLAT WASHER	3.000	PC																														
GN1546A0	SHAFT GASKET D8	1.000	PC																														
VI1695A0	M6x16 H6 CH10 STAINLESS STEEL NUT	1.000	PC																														
VI1700A0	18x6.4x1.5 STAINLESS STEEL FLAT WASHER	1.000	PC																														
VI1836A0	M6x12 OT63 ROTOR SCRE	3.000	PC																														
VN1035B1	LINE MISS 230 VAC MOTOR	1.000	PC																														

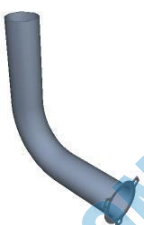

COMPONENT			SPARE PART																						
Code	Description	Image	Code	Description	Kit components																				
VN1182A	M6 NUT 24 BLADES H60 D120 FAN		KVN1182A	SPEED.Pro COOLING FAN KIT	<table border="1"> <thead> <tr> <th>Code</th> <th>Description</th> <th>Qty</th> <th>UOM</th> </tr> </thead> <tbody> <tr> <td>VI1110A0</td> <td>AUTOBLOCKI NG NUT STAINLESS STEEL</td> <td>1.000</td> <td>PC</td> </tr> <tr> <td>VN1182A0</td> <td>M6 NUT 24 BLADES H60 D120 FAN</td> <td>1.000</td> <td>PC</td> </tr> </tbody> </table>	Code	Description	Qty	UOM	VI1110A0	AUTOBLOCKI NG NUT STAINLESS STEEL	1.000	PC	VN1182A0	M6 NUT 24 BLADES H60 D120 FAN	1.000	PC								
Code	Description	Qty	UOM																						
VI1110A0	AUTOBLOCKI NG NUT STAINLESS STEEL	1.000	PC																						
VN1182A0	M6 NUT 24 BLADES H60 D120 FAN	1.000	PC																						
OH5247A	OH5247A1		OH5247A1	OH5247A1																					
OH5248A	OH5248A1		OH5248A1	OH5248A1																					
GN1430B	MW GUIDE PTFE GASKET		GN1430B0	MW GUIDE PTFE GASKET																					
RS1018A	2x1600W 230V+210W CIRCULAR HEAT. ELEMENT		KRS1018A	SPEED.PRO HEATING ELEMENT KIT	<table border="1"> <thead> <tr> <th>Code</th> <th>Description</th> <th>Qty</th> <th>UOM</th> </tr> </thead> <tbody> <tr> <td>OH5280A0</td> <td>MW HEATING ELEMENT PLATE</td> <td>1.000</td> <td>PC</td> </tr> <tr> <td>GN1671A0</td> <td>141X22 G8.5 ELEMENT ARMED GASKET</td> <td>1.000</td> <td>PC</td> </tr> <tr> <td>RS1018A0</td> <td>2x1600W 230V+210W CIRCULAR HEAT. ELEMENT</td> <td>1.000</td> <td>PC</td> </tr> <tr> <td>VI1077A1</td> <td>SCREW M6x12 TE INOX</td> <td>3.000</td> <td>PC</td> </tr> </tbody> </table>	Code	Description	Qty	UOM	OH5280A0	MW HEATING ELEMENT PLATE	1.000	PC	GN1671A0	141X22 G8.5 ELEMENT ARMED GASKET	1.000	PC	RS1018A0	2x1600W 230V+210W CIRCULAR HEAT. ELEMENT	1.000	PC	VI1077A1	SCREW M6x12 TE INOX	3.000	PC
Code	Description	Qty	UOM																						
OH5280A0	MW HEATING ELEMENT PLATE	1.000	PC																						
GN1671A0	141X22 G8.5 ELEMENT ARMED GASKET	1.000	PC																						
RS1018A0	2x1600W 230V+210W CIRCULAR HEAT. ELEMENT	1.000	PC																						
VI1077A1	SCREW M6x12 TE INOX	3.000	PC																						

COMPONENT			SPARE PART																																						
Code	Description	Image	Code	Description	Kit components																																				
RS1018A	2x1600W 230V+210W CIRCULAR HEAT. ELEMENT		KRS1018A	SPEED.PRO HEATING ELEMENT KIT	<table border="1"> <thead> <tr> <th>Code</th> <th>Description</th> <th>Qty</th> <th>UOM</th> </tr> </thead> <tbody> <tr> <td>VI1220A1</td> <td>4,2x12 TCB SELF-TAPPIN G SCREW</td> <td>6.000</td> <td>PC</td> </tr> <tr> <td>VM1794A0</td> <td>250x4.8 PA66 BLACK CLAMP</td> <td>2.000</td> <td>PC</td> </tr> <tr> <td>VM2103A0</td> <td>CLAMP LOCK</td> <td>2.000</td> <td>PC</td> </tr> </tbody> </table>	Code	Description	Qty	UOM	VI1220A1	4,2x12 TCB SELF-TAPPIN G SCREW	6.000	PC	VM1794A0	250x4.8 PA66 BLACK CLAMP	2.000	PC	VM2103A0	CLAMP LOCK	2.000	PC																				
Code	Description	Qty	UOM																																						
VI1220A1	4,2x12 TCB SELF-TAPPIN G SCREW	6.000	PC																																						
VM1794A0	250x4.8 PA66 BLACK CLAMP	2.000	PC																																						
VM2103A0	CLAMP LOCK	2.000	PC																																						
TB2714A	BAFFLE CHIMNEY		TB2714A1	BAFFLE CHIMNEY																																					
TR1105A	L1000 PT100 TEMPERATURE PROBE		KTR1105A	PT100 L1000 TEMPERATURE PROBE KIT	<table border="1"> <thead> <tr> <th>Code</th> <th>Description</th> <th>Qty</th> <th>UOM</th> </tr> </thead> <tbody> <tr> <td>GN1120A1</td> <td>NTC TEMPERATUR E PROBE SEAL</td> <td>1.000</td> <td>PC</td> </tr> <tr> <td>GN1285A0</td> <td>NTC TEMPERATUR E PROBE SEALING</td> <td>1.000</td> <td>PC</td> </tr> <tr> <td>SL1045A0</td> <td>S57 BLACK SILICONE - 80ml CARTRIDGE</td> <td>1.000</td> <td>PC</td> </tr> <tr> <td>TR1105A4</td> <td>L1000 PT100 TEMPERATUR E PROBE</td> <td>1.000</td> <td>PC</td> </tr> <tr> <td>VI1220A1</td> <td>4,2x12 TCB SELF-TAPPIN G SCREW</td> <td>2.000</td> <td>PC</td> </tr> <tr> <td>VM1464A1</td> <td>CT BT TEMPERATUR E PROBE COVER</td> <td>1.000</td> <td>PC</td> </tr> <tr> <td>VM1465A1</td> <td>CT BT TEMPERATUR E PROBE COVER</td> <td>1.000</td> <td>PC</td> </tr> <tr> <td>VM2052A0</td> <td>LM CORE PROBE COVE</td> <td>1.000</td> <td>PC</td> </tr> </tbody> </table>	Code	Description	Qty	UOM	GN1120A1	NTC TEMPERATUR E PROBE SEAL	1.000	PC	GN1285A0	NTC TEMPERATUR E PROBE SEALING	1.000	PC	SL1045A0	S57 BLACK SILICONE - 80ml CARTRIDGE	1.000	PC	TR1105A4	L1000 PT100 TEMPERATUR E PROBE	1.000	PC	VI1220A1	4,2x12 TCB SELF-TAPPIN G SCREW	2.000	PC	VM1464A1	CT BT TEMPERATUR E PROBE COVER	1.000	PC	VM1465A1	CT BT TEMPERATUR E PROBE COVER	1.000	PC	VM2052A0	LM CORE PROBE COVE	1.000	PC
Code	Description	Qty	UOM																																						
GN1120A1	NTC TEMPERATUR E PROBE SEAL	1.000	PC																																						
GN1285A0	NTC TEMPERATUR E PROBE SEALING	1.000	PC																																						
SL1045A0	S57 BLACK SILICONE - 80ml CARTRIDGE	1.000	PC																																						
TR1105A4	L1000 PT100 TEMPERATUR E PROBE	1.000	PC																																						
VI1220A1	4,2x12 TCB SELF-TAPPIN G SCREW	2.000	PC																																						
VM1464A1	CT BT TEMPERATUR E PROBE COVER	1.000	PC																																						
VM1465A1	CT BT TEMPERATUR E PROBE COVER	1.000	PC																																						
VM2052A0	LM CORE PROBE COVE	1.000	PC																																						

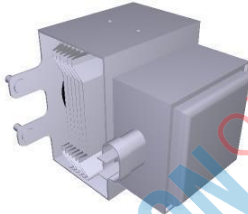
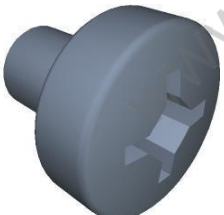
COMPONENT			SPARE PART																		
Code	Description	Image	Code	Description	Kit components																
TR1164A	10AMP 90°C NC SNAP ACTION THERMOSTAT		KTR1164A	SPEED.PRO THERMOSTAT KIT	<table border="1"> <thead> <tr> <th>Code</th> <th>Description</th> <th>Qty</th> <th>UOM</th> </tr> </thead> <tbody> <tr> <td>TR1164A0</td> <td>10AMP 90°C NC SNAP ACTION THERMOSTAT</td> <td>1.000</td> <td>PC</td> </tr> </tbody> </table>	Code	Description	Qty	UOM	TR1164A0	10AMP 90°C NC SNAP ACTION THERMOSTAT	1.000	PC								
Code	Description	Qty	UOM																		
TR1164A0	10AMP 90°C NC SNAP ACTION THERMOSTAT	1.000	PC																		
VE1800A	4-SB 2M303 1080W MAGNETRON		KVE1800A	SPEED.Pro 1080W MAGNETRON KIT	<table border="1"> <thead> <tr> <th>Code</th> <th>Description</th> <th>Qty</th> <th>UOM</th> </tr> </thead> <tbody> <tr> <td>TR1164A0</td> <td>10AMP 90°C NC SNAP ACTION THERMOSTAT</td> <td>1.000</td> <td>PC</td> </tr> <tr> <td>VE1800A0</td> <td>4-SB 2M303 1080W MAGNETRON</td> <td>1.000</td> <td>PC</td> </tr> <tr> <td>VI2037A1</td> <td>40X8 TORX SHEETTRACS SELF-THREAD SCREW</td> <td>2.000</td> <td>PC</td> </tr> </tbody> </table>	Code	Description	Qty	UOM	TR1164A0	10AMP 90°C NC SNAP ACTION THERMOSTAT	1.000	PC	VE1800A0	4-SB 2M303 1080W MAGNETRON	1.000	PC	VI2037A1	40X8 TORX SHEETTRACS SELF-THREAD SCREW	2.000	PC
Code	Description	Qty	UOM																		
TR1164A0	10AMP 90°C NC SNAP ACTION THERMOSTAT	1.000	PC																		
VE1800A0	4-SB 2M303 1080W MAGNETRON	1.000	PC																		
VI2037A1	40X8 TORX SHEETTRACS SELF-THREAD SCREW	2.000	PC																		
VI1126A	CH8 M5 ST STEEL BLIND NUT		VI1126A0	CH8 M5 ST STEEL BLIND NUT																	
VI1127A	M6x8 ST STEEL CROSS PAN HEAD SCREW		VI1127A0	M6x8 ST STEEL CROSS PAN HEAD SCREW																	
VM1443A	SPEED.Pro CATALYTIC CONVERTER		KVM1443A	SPEED.Pro CATALYTIC CONVERTER 2PCS KIT	<table border="1"> <thead> <tr> <th>Code</th> <th>Description</th> <th>Qty</th> <th>UOM</th> </tr> </thead> <tbody> <tr> <td>VI1127A0</td> <td>M6x8 ST STEEL CROSS PAN HEAD SCREW</td> <td>4.000</td> <td>PC</td> </tr> <tr> <td>VM1443A0</td> <td>SPEED.Pro CATALYTIC CONVERTER</td> <td>2.000</td> <td>PC</td> </tr> </tbody> </table>	Code	Description	Qty	UOM	VI1127A0	M6x8 ST STEEL CROSS PAN HEAD SCREW	4.000	PC	VM1443A0	SPEED.Pro CATALYTIC CONVERTER	2.000	PC				
Code	Description	Qty	UOM																		
VI1127A0	M6x8 ST STEEL CROSS PAN HEAD SCREW	4.000	PC																		
VM1443A0	SPEED.Pro CATALYTIC CONVERTER	2.000	PC																		



ASM3226A/0.D06 - External cover

FRONT





ASM3226A/0.D06 - External cover



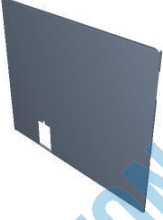
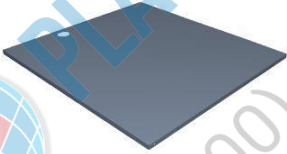
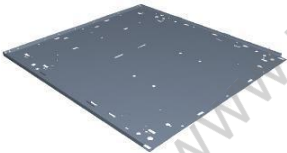

REAR









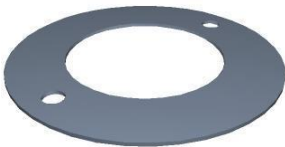

COMPONENT			SPARE PART		
Code	Description	Image	Code	Description	Kit components
0D2491A	MW RIGHT SIDE PANEL		0D2491A1	MW RIGHT SIDE PANEL	
0D2492A	XESW LEFT EXTERNAL PANEL		0D2492A1	XESW LEFT EXTERNAL PANEL	
0D2493A	MW COVER		0D2493A1	MW COVER	
0E1029A	EXTERNAL BOTTOM COVER MW		0E1029A1	EXTERNAL BOTTOM COVER MW	
0F1038A	MW BACK PANEL		0F1038A3	MW BACK PANEL	

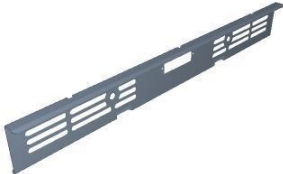
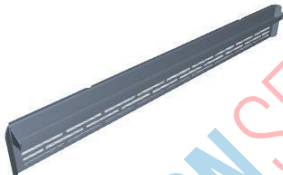

COMPONENT			SPARE PART		
Code	Description	Image	Code	Description	Kit components
0H2919B	SPEED.PRO SHORT SPRING BRACKET + WASHER		0H2919B0	SPEED.PRO SHORT SPRING BRACKET + WASHER	
0H4587A	US SPEED.Pro THERMOSTAT SUPPORT		0H4587A0	US SPEED.Pro THERMOSTAT SUPPORT	
0H5254A	0H5254A1		0H5254A1	0H5254A1	
0H5255A	0H5255A1		0H5255A1	0H5255A1	
0H5256A	0H5256A1		0H5256A1	0H5256A1	



COMPONENT			SPARE PART																																						
Code	Description	Image	Code	Description	Kit components																																				
0H5258A	0H5258A1		0H5258A1	0H5258A1																																					
0H5285A	SPEED.PRO FRONT AIR FILTER		K0H5285A	SPEED.Pro FRONT AIR FILTER KIT	<table border="1"> <thead> <tr> <th>Code</th> <th>Description</th> <th>Qty</th> <th>UOM</th> </tr> </thead> <tbody> <tr> <td>0H5285A0</td> <td>SPEED.PRO FRONT AIR FILTER</td> <td>1.000</td> <td>PC</td> </tr> </tbody> </table>	Code	Description	Qty	UOM	0H5285A0	SPEED.PRO FRONT AIR FILTER	1.000	PC																												
Code	Description	Qty	UOM																																						
0H5285A0	SPEED.PRO FRONT AIR FILTER	1.000	PC																																						
0H5274A	SPEED.PRO DOOR MICROSWITCH FIXING		0H5274A1	SPEED.PRO DOOR MICROSWITCH FIXING																																					
VE1820A	MW NO-NC BIPOLAR MICROSWITCH		KVE1820A	SPEED.Pro DOOR MICROSWITCH 2PCS KIT	<table border="1"> <thead> <tr> <th>Code</th> <th>Description</th> <th>Qty</th> <th>UOM</th> </tr> </thead> <tbody> <tr> <td>0H5274A1</td> <td>SPEED.PRO DOOR MICROSWITCH FIXING</td> <td>2.000</td> <td>PC</td> </tr> <tr> <td>IE3620A0</td> <td></td> <td>1.000</td> <td>PC</td> </tr> <tr> <td>IE3621A0</td> <td></td> <td>1.000</td> <td>PC</td> </tr> <tr> <td>VE1820A0</td> <td>MW NO-NC BIPOLAR MICROSWITCH</td> <td>1.000</td> <td>PC</td> </tr> <tr> <td>VE1825A0</td> <td>MW NO-NO BIPOLAR MICROSWITCH</td> <td>1.000</td> <td>PC</td> </tr> <tr> <td>VI2037A1</td> <td>40X8 TORX SHEETTRACS SELF-THREAD SCREW</td> <td>4.000</td> <td>PC</td> </tr> <tr> <td>VP1027A0</td> <td>MW MICROSWITCH H SUPPORT</td> <td>2.000</td> <td>PC</td> </tr> <tr> <td>VP1028A0</td> <td>MICRO MW FIXING CAP</td> <td>4.000</td> <td>PC</td> </tr> </tbody> </table>	Code	Description	Qty	UOM	0H5274A1	SPEED.PRO DOOR MICROSWITCH FIXING	2.000	PC	IE3620A0		1.000	PC	IE3621A0		1.000	PC	VE1820A0	MW NO-NC BIPOLAR MICROSWITCH	1.000	PC	VE1825A0	MW NO-NO BIPOLAR MICROSWITCH	1.000	PC	VI2037A1	40X8 TORX SHEETTRACS SELF-THREAD SCREW	4.000	PC	VP1027A0	MW MICROSWITCH H SUPPORT	2.000	PC	VP1028A0	MICRO MW FIXING CAP	4.000	PC
Code	Description	Qty	UOM																																						
0H5274A1	SPEED.PRO DOOR MICROSWITCH FIXING	2.000	PC																																						
IE3620A0		1.000	PC																																						
IE3621A0		1.000	PC																																						
VE1820A0	MW NO-NC BIPOLAR MICROSWITCH	1.000	PC																																						
VE1825A0	MW NO-NO BIPOLAR MICROSWITCH	1.000	PC																																						
VI2037A1	40X8 TORX SHEETTRACS SELF-THREAD SCREW	4.000	PC																																						
VP1027A0	MW MICROSWITCH H SUPPORT	2.000	PC																																						
VP1028A0	MICRO MW FIXING CAP	4.000	PC																																						

COMPONENT			SPARE PART																																						
Code	Description	Image	Code	Description	Kit components																																				
VP1027A	MW MICROSWITCH SUPPORT		KVP1027A	MW DOOR MICROSWITCH HOLDER 2 PCS KIT	<table border="1"> <thead> <tr> <th>Code</th> <th>Description</th> <th>Qty</th> <th>UOM</th> </tr> </thead> <tbody> <tr> <td>VI2037A1</td> <td>40X8 TORX SHEETTRACS SELF-THREAD SCREW</td> <td>4.000</td> <td>PC</td> </tr> <tr> <td>VP1027A0</td> <td>MW MICROSWITCH H SUPPORT</td> <td>2.000</td> <td>PC</td> </tr> <tr> <td>VP1028A0</td> <td>MICRO MW FIXING CAP</td> <td>4.000</td> <td>PC</td> </tr> </tbody> </table>	Code	Description	Qty	UOM	VI2037A1	40X8 TORX SHEETTRACS SELF-THREAD SCREW	4.000	PC	VP1027A0	MW MICROSWITCH H SUPPORT	2.000	PC	VP1028A0	MICRO MW FIXING CAP	4.000	PC																				
Code	Description	Qty	UOM																																						
VI2037A1	40X8 TORX SHEETTRACS SELF-THREAD SCREW	4.000	PC																																						
VP1027A0	MW MICROSWITCH H SUPPORT	2.000	PC																																						
VP1028A0	MICRO MW FIXING CAP	4.000	PC																																						
VP1028A	MICRO MW FIXING CAP		VP1028A0	MICRO MW FIXING CAP																																					
0H5274A	SPEED.PRO DOOR MICROSWITCH FIXING		0H5274A1	SPEED.PRO DOOR MICROSWITCH FIXING																																					
VE1825A	MW NO-NO BIPOLAR MICROSWITCH		KVE1820A	SPEED.Pro DOOR MICROSWITCH 2PCS KIT	<table border="1"> <thead> <tr> <th>Code</th> <th>Description</th> <th>Qty</th> <th>UOM</th> </tr> </thead> <tbody> <tr> <td>0H5274A1</td> <td>SPEED.PRO DOOR MICROSWITCH H FIXING</td> <td>2.000</td> <td>PC</td> </tr> <tr> <td>IE3620A0</td> <td></td> <td>1.000</td> <td>PC</td> </tr> <tr> <td>IE3621A0</td> <td></td> <td>1.000</td> <td>PC</td> </tr> <tr> <td>VE1820A0</td> <td>MW NO-NC BIPOLAR MICROSWITCH</td> <td>1.000</td> <td>PC</td> </tr> <tr> <td>VE1825A0</td> <td>MW NO-NO BIPOLAR MICROSWITCH</td> <td>1.000</td> <td>PC</td> </tr> <tr> <td>VI2037A1</td> <td>40X8 TORX SHEETTRACS SELF-THREAD SCREW</td> <td>4.000</td> <td>PC</td> </tr> <tr> <td>VP1027A0</td> <td>MW MICROSWITCH H SUPPORT</td> <td>2.000</td> <td>PC</td> </tr> <tr> <td>VP1028A0</td> <td>MICRO MW FIXING CAP</td> <td>4.000</td> <td>PC</td> </tr> </tbody> </table>	Code	Description	Qty	UOM	0H5274A1	SPEED.PRO DOOR MICROSWITCH H FIXING	2.000	PC	IE3620A0		1.000	PC	IE3621A0		1.000	PC	VE1820A0	MW NO-NC BIPOLAR MICROSWITCH	1.000	PC	VE1825A0	MW NO-NO BIPOLAR MICROSWITCH	1.000	PC	VI2037A1	40X8 TORX SHEETTRACS SELF-THREAD SCREW	4.000	PC	VP1027A0	MW MICROSWITCH H SUPPORT	2.000	PC	VP1028A0	MICRO MW FIXING CAP	4.000	PC
Code	Description	Qty	UOM																																						
0H5274A1	SPEED.PRO DOOR MICROSWITCH H FIXING	2.000	PC																																						
IE3620A0		1.000	PC																																						
IE3621A0		1.000	PC																																						
VE1820A0	MW NO-NC BIPOLAR MICROSWITCH	1.000	PC																																						
VE1825A0	MW NO-NO BIPOLAR MICROSWITCH	1.000	PC																																						
VI2037A1	40X8 TORX SHEETTRACS SELF-THREAD SCREW	4.000	PC																																						
VP1027A0	MW MICROSWITCH H SUPPORT	2.000	PC																																						
VP1028A0	MICRO MW FIXING CAP	4.000	PC																																						







COMPONENT			SPARE PART																		
Code	Description	Image	Code	Description	Kit components																
VP1027A	MW MICROSWITCH SUPPORT		KVP1027A	MW DOOR MICROSWITCH HOLDER 2 PCS KIT	<table border="1"> <thead> <tr> <th>Code</th> <th>Description</th> <th>Qty</th> <th>UOM</th> </tr> </thead> <tbody> <tr> <td>VI2037A1</td> <td>40X8 TORX SHEETTRACS SELF-THREAD SCREW</td> <td>4.000</td> <td>PC</td> </tr> <tr> <td>VP1027A0</td> <td>MW MICROSWITCH H SUPPORT</td> <td>2.000</td> <td>PC</td> </tr> <tr> <td>VP1028A0</td> <td>MICRO MW FIXING CAP</td> <td>4.000</td> <td>PC</td> </tr> </tbody> </table>	Code	Description	Qty	UOM	VI2037A1	40X8 TORX SHEETTRACS SELF-THREAD SCREW	4.000	PC	VP1027A0	MW MICROSWITCH H SUPPORT	2.000	PC	VP1028A0	MICRO MW FIXING CAP	4.000	PC
Code	Description	Qty	UOM																		
VI2037A1	40X8 TORX SHEETTRACS SELF-THREAD SCREW	4.000	PC																		
VP1027A0	MW MICROSWITCH H SUPPORT	2.000	PC																		
VP1028A0	MICRO MW FIXING CAP	4.000	PC																		
VP1028A	MICRO MW FIXING CAP		VP1028A0	MICRO MW FIXING CAP																	
VE1295A	MK 16A 230V DOOR MICROSWITCH		KVE1295A	16A 230V DOOR MICROSWITCH KIT	<table border="1"> <thead> <tr> <th>Code</th> <th>Description</th> <th>Qty</th> <th>UOM</th> </tr> </thead> <tbody> <tr> <td>VE1295A0</td> <td>MK 16A 230V DOOR MICROSWITC</td> <td>1.000</td> <td>PC</td> </tr> </tbody> </table>	Code	Description	Qty	UOM	VE1295A0	MK 16A 230V DOOR MICROSWITC	1.000	PC								
Code	Description	Qty	UOM																		
VE1295A0	MK 16A 230V DOOR MICROSWITC	1.000	PC																		
VM1200A	DOOR MECHANIC MICROSWITCH SUPPORT PLATE		VM1200A0	DOOR MECHANIC MICROSWITCH SUPPORT PLATE																	
VP1028A	MICRO MW FIXING CAP		VP1028A0	MICRO MW FIXING CAP																	



COMPONENT			SPARE PART																		
Code	Description	Image	Code	Description	Kit components																
VP1049A	MW AIR OUTLET GRID		KVP1049A	SPEED.Pro AIR OUTLET GRID KIT	<table border="1"> <thead> <tr> <th>Code</th> <th>Description</th> <th>Qty</th> <th>UOM</th> </tr> </thead> <tbody> <tr> <td>VI2037A1</td> <td>40X8 TORX SHEETTRACS SELF-THREAD SCREW</td> <td>1.000</td> <td>PC</td> </tr> <tr> <td>VP1028A0</td> <td>MICRO MW FIXING CAP</td> <td>1.000</td> <td>PC</td> </tr> <tr> <td>VP1049A1</td> <td>MW AIR OUTLET GRID</td> <td>1.000</td> <td>PC</td> </tr> </tbody> </table>	Code	Description	Qty	UOM	VI2037A1	40X8 TORX SHEETTRACS SELF-THREAD SCREW	1.000	PC	VP1028A0	MICRO MW FIXING CAP	1.000	PC	VP1049A1	MW AIR OUTLET GRID	1.000	PC
Code	Description	Qty	UOM																		
VI2037A1	40X8 TORX SHEETTRACS SELF-THREAD SCREW	1.000	PC																		
VP1028A0	MICRO MW FIXING CAP	1.000	PC																		
VP1049A1	MW AIR OUTLET GRID	1.000	PC																		
0H2598A	0H2598A0		0H2598A0	0H2598A0																	
0H5260A	0H5260A1		0H5260A1	0H5260A1																	
GN1680A	GN1680A0		GN1680A0	GN1680A0																	
VN1165A	230Vac 50/60Hz COOLING DOWN FA		KVN1165A	S.5E ADVANCE/MM 230V COOLING FAN KIT	<table border="1"> <thead> <tr> <th>Code</th> <th>Description</th> <th>Qty</th> <th>UOM</th> </tr> </thead> <tbody> <tr> <td>VI1099A0</td> <td>SELF-DRILLIN G SCREW 4.8X13 TCB+ Z</td> <td>4.000</td> <td>PC</td> </tr> <tr> <td>VM1555A2</td> <td>CT BT COOLING FAN SUPPORT</td> <td>1.000</td> <td>PC</td> </tr> <tr> <td>VN1165A0</td> <td>230Vac 50/60Hz COOLING DOWN FAN</td> <td>1.000</td> <td>PC</td> </tr> </tbody> </table>	Code	Description	Qty	UOM	VI1099A0	SELF-DRILLIN G SCREW 4.8X13 TCB+ Z	4.000	PC	VM1555A2	CT BT COOLING FAN SUPPORT	1.000	PC	VN1165A0	230Vac 50/60Hz COOLING DOWN FAN	1.000	PC
Code	Description	Qty	UOM																		
VI1099A0	SELF-DRILLIN G SCREW 4.8X13 TCB+ Z	4.000	PC																		
VM1555A2	CT BT COOLING FAN SUPPORT	1.000	PC																		
VN1165A0	230Vac 50/60Hz COOLING DOWN FAN	1.000	PC																		

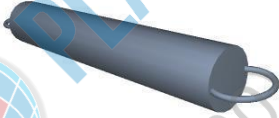

COMPONENT			SPARE PART																		
Code	Description	Image	Code	Description	Kit components																
0H2598A	0H2598A0		0H2598A0	0H2598A0																	
0H5259A	0H5259A1		0H5259A1	0H5259A1																	
GN1680A	GN1680A0		GN1680A0	GN1680A0																	
VN1165A	230Vac 50/60Hz COOLING DOWN FA		KVN1165A	S.5E ADVANCE/MM 230V COOLING FAN KIT	<table border="1"> <thead> <tr> <th>Code</th> <th>Description</th> <th>Qty</th> <th>UOM</th> </tr> </thead> <tbody> <tr> <td>V11099A0</td> <td>SELF-DRILLIN G SCREW 4.8X13 TCB+ Z</td> <td>4.000</td> <td>PC</td> </tr> <tr> <td>VM1555A2</td> <td>CT BT COOLING FAN SUPPORT</td> <td>1.000</td> <td>PC</td> </tr> <tr> <td>VN1165A0</td> <td>230Vac 50/60Hz COOLING DOWN FAN</td> <td>1.000</td> <td>PC</td> </tr> </tbody> </table>	Code	Description	Qty	UOM	V11099A0	SELF-DRILLIN G SCREW 4.8X13 TCB+ Z	4.000	PC	VM1555A2	CT BT COOLING FAN SUPPORT	1.000	PC	VN1165A0	230Vac 50/60Hz COOLING DOWN FAN	1.000	PC
Code	Description	Qty	UOM																		
V11099A0	SELF-DRILLIN G SCREW 4.8X13 TCB+ Z	4.000	PC																		
VM1555A2	CT BT COOLING FAN SUPPORT	1.000	PC																		
VN1165A0	230Vac 50/60Hz COOLING DOWN FAN	1.000	PC																		
CE1355A	CABLE 5 X 2,5 MMQ H07RNF L = 1,5 MT		KCE1355A	L=1.5M 5x2.5mmq POWER CABLE KIT	<table border="1"> <thead> <tr> <th>Code</th> <th>Description</th> <th>Qty</th> <th>UOM</th> </tr> </thead> <tbody> <tr> <td>CE1355A1</td> <td>CABLE 5 X 2,5 MMQ H07RNF L = 1,5 MT</td> <td>1.000</td> <td>PC</td> </tr> </tbody> </table>	Code	Description	Qty	UOM	CE1355A1	CABLE 5 X 2,5 MMQ H07RNF L = 1,5 MT	1.000	PC								
Code	Description	Qty	UOM																		
CE1355A1	CABLE 5 X 2,5 MMQ H07RNF L = 1,5 MT	1.000	PC																		

COMPONENT			SPARE PART																										
Code	Description	Image	Code	Description	Kit components																								
GN1431A	GN1431A1		GN1431A1	GN1431A1																									
ML1018B	De24.4 H44 12 SPIR PULL SPRING		KML1018B	SPEED.PRO DOOR SPRING 2PCS KIT	<table border="1"> <thead> <tr> <th>Code</th> <th>Description</th> <th>Qty</th> <th>UOM</th> </tr> </thead> <tbody> <tr> <td>ML1018B0</td> <td>De24.4 H44 12 SPIR PULL SPRING</td> <td>2.000</td> <td>PC</td> </tr> </tbody> </table>	Code	Description	Qty	UOM	ML1018B0	De24.4 H44 12 SPIR PULL SPRING	2.000	PC																
Code	Description	Qty	UOM																										
ML1018B0	De24.4 H44 12 SPIR PULL SPRING	2.000	PC																										
ML1019A	L0166 K0.38 Dm21.8 TRACTION SPRING		KML1019A	SPEED.PRO HINGE SPRINGS KIT	<table border="1"> <thead> <tr> <th>Code</th> <th>Description</th> <th>Qty</th> <th>UOM</th> </tr> </thead> <tbody> <tr> <td>ML1019A0</td> <td>L0166 K0.38 Dm21.8 TRACTION SPRING</td> <td>2.000</td> <td>PC</td> </tr> </tbody> </table>	Code	Description	Qty	UOM	ML1019A0	L0166 K0.38 Dm21.8 TRACTION SPRING	2.000	PC																
Code	Description	Qty	UOM																										
ML1019A0	L0166 K0.38 Dm21.8 TRACTION SPRING	2.000	PC																										
TR1136A	318°C -0/+24 1 POLE SAFETY THERMOSTAT		KTR1136A	318°C -0/+24 SAFETY THERMOSTAT KIT	<table border="1"> <thead> <tr> <th>Code</th> <th>Description</th> <th>Qty</th> <th>UOM</th> </tr> </thead> <tbody> <tr> <td>0H7030A0</td> <td>THERMOSTAT BULB INLET COVER</td> <td>1.000</td> <td>PC</td> </tr> <tr> <td>GN1531A0</td> <td>THERMOSTAT BULB INLET SEALING</td> <td>1.000</td> <td>PC</td> </tr> <tr> <td>SL1045A0</td> <td>S57 BLACK SILICONE - 80ml CARTRIDGE</td> <td>1.000</td> <td>PC</td> </tr> <tr> <td>TR1136A0</td> <td>318°C -0/+24 1 POLE SAFETY THERMOSTAT</td> <td>1.000</td> <td>PC</td> </tr> <tr> <td>VI1220A1</td> <td>4,2x12 TCB SELF-TAPPIN G SCREW</td> <td>3.000</td> <td>PC</td> </tr> </tbody> </table>	Code	Description	Qty	UOM	0H7030A0	THERMOSTAT BULB INLET COVER	1.000	PC	GN1531A0	THERMOSTAT BULB INLET SEALING	1.000	PC	SL1045A0	S57 BLACK SILICONE - 80ml CARTRIDGE	1.000	PC	TR1136A0	318°C -0/+24 1 POLE SAFETY THERMOSTAT	1.000	PC	VI1220A1	4,2x12 TCB SELF-TAPPIN G SCREW	3.000	PC
Code	Description	Qty	UOM																										
0H7030A0	THERMOSTAT BULB INLET COVER	1.000	PC																										
GN1531A0	THERMOSTAT BULB INLET SEALING	1.000	PC																										
SL1045A0	S57 BLACK SILICONE - 80ml CARTRIDGE	1.000	PC																										
TR1136A0	318°C -0/+24 1 POLE SAFETY THERMOSTAT	1.000	PC																										
VI1220A1	4,2x12 TCB SELF-TAPPIN G SCREW	3.000	PC																										



COMPONENT			SPARE PART																						
Code	Description	Image	Code	Description	Kit components																				
VE1607A	RUBBER MAGNETIC SUCTION CUP		KVE1607A	MAGNETIC SUCTION CUP	<table border="1"> <thead> <tr> <th>Code</th> <th>Description</th> <th>Qty</th> <th>UOM</th> </tr> </thead> <tbody> <tr> <td>VE1607A1</td> <td>RUBBER MAGNETIC SUCTION CUP</td> <td>2.000</td> <td>PC</td> </tr> <tr> <td>VI1700A0</td> <td>18x6.4x1.5 STAINLESS STEEL FLAT WASHER</td> <td>2.000</td> <td>PC</td> </tr> </tbody> </table>	Code	Description	Qty	UOM	VE1607A1	RUBBER MAGNETIC SUCTION CUP	2.000	PC	VI1700A0	18x6.4x1.5 STAINLESS STEEL FLAT WASHER	2.000	PC								
Code	Description	Qty	UOM																						
VE1607A1	RUBBER MAGNETIC SUCTION CUP	2.000	PC																						
VI1700A0	18x6.4x1.5 STAINLESS STEEL FLAT WASHER	2.000	PC																						
VI1136A	M5 UNI-1751 ST.STEEL SPRING WASHER		VI1136A0	M5 UNI-1751 ST.STEEL SPRING WASHER																					
VI1328A	VI1328A0		VI1328A0	VI1328A0																					
VM1222A	CABLE LOCKS SP ACCESSORIES EL CONNECTION		VM1222A0	CABLE LOCKS SP ACCESSORIES EL CONNECTION																					
VM1570A	SPEED.PRO RIGHT HINGE SET		KVM1570A	SPEED.Pro RIGHT HINGE SET KIT	<table border="1"> <thead> <tr> <th>Code</th> <th>Description</th> <th>Qty</th> <th>UOM</th> </tr> </thead> <tbody> <tr> <td>0H2919B0</td> <td>SPEED.PRO SHORT SPRING BRACKET + WASHER</td> <td>1.000</td> <td>PC</td> </tr> <tr> <td>VI1136A0</td> <td>M5 UNI-1751 ST.STEEL SPRING WASHER</td> <td>8.000</td> <td>PC</td> </tr> <tr> <td>VI1280A1</td> <td>M5x10 TC1/2T SCREW</td> <td>8.000</td> <td>PC</td> </tr> <tr> <td>VM1570A1</td> <td>SPEED.PRO RIGHT HINGE SET</td> <td>1.000</td> <td>PC</td> </tr> </tbody> </table>	Code	Description	Qty	UOM	0H2919B0	SPEED.PRO SHORT SPRING BRACKET + WASHER	1.000	PC	VI1136A0	M5 UNI-1751 ST.STEEL SPRING WASHER	8.000	PC	VI1280A1	M5x10 TC1/2T SCREW	8.000	PC	VM1570A1	SPEED.PRO RIGHT HINGE SET	1.000	PC
Code	Description	Qty	UOM																						
0H2919B0	SPEED.PRO SHORT SPRING BRACKET + WASHER	1.000	PC																						
VI1136A0	M5 UNI-1751 ST.STEEL SPRING WASHER	8.000	PC																						
VI1280A1	M5x10 TC1/2T SCREW	8.000	PC																						
VM1570A1	SPEED.PRO RIGHT HINGE SET	1.000	PC																						

COMPONENT			SPARE PART																																																															
Code	Description	Image	Code	Description	Kit components																																																													
VM1570A	SPEED.PRO RIGHT HINGE SET		KCR1131A	SPEED.Pro COMPLETE RIGHT HINGE KIT	<table border="1"> <thead> <tr> <th>Code</th> <th>Description</th> <th>Qty</th> <th>UOM</th> </tr> </thead> <tbody> <tr> <td>0H2574A0</td> <td>SPEED PRO DOOR PIN BRACKET</td> <td>1.000</td> <td>PC</td> </tr> <tr> <td>0H2918A0</td> <td>SPEED PRO HINGE TIE ROD WITH WASHERS</td> <td>1.000</td> <td>PC</td> </tr> <tr> <td>0H2919B0</td> <td>SPEED.PRO SHORT SPRING BRACKET + WASHER</td> <td>1.000</td> <td>PC</td> </tr> <tr> <td>ML1018B0</td> <td>De24.4 H44 12 SPIR PULL SPRING</td> <td>1.000</td> <td>PC</td> </tr> <tr> <td>ML1019A0</td> <td>L0166 K0.38 Dm21.8 TRACTION SPRING</td> <td>1.000</td> <td>PC</td> </tr> <tr> <td>VI1074A0</td> <td>4X16 SCREW FOR PLASTIC</td> <td>3.000</td> <td>PC</td> </tr> <tr> <td>VI1136A0</td> <td>M5 UNI-1751 ST.STEEL SPRING WASHER</td> <td>8.000</td> <td>PC</td> </tr> <tr> <td>VI1280A1</td> <td>M5x10 TC1/2T SCREW</td> <td>8.000</td> <td>PC</td> </tr> <tr> <td>VI1875A0</td> <td>SCREW M5X10 TC1/2T INOX</td> <td>7.000</td> <td>PC</td> </tr> <tr> <td>VM1524A0</td> <td>D 24 d 8 B 8 MW HINGE BEARING</td> <td>2.000</td> <td>PC</td> </tr> <tr> <td>VM1533A0</td> <td>SPEED.PRO DOOR FULCRUM PIN</td> <td>1.000</td> <td>PC</td> </tr> <tr> <td>VM1534A0</td> <td>SPEED.PRO DOOR HOLDER BEARING PIN</td> <td>1.000</td> <td>PC</td> </tr> <tr> <td>VM1570A1</td> <td>SPEED.PRO RIGHT HINGE SET</td> <td>1.000</td> <td>PC</td> </tr> <tr> <td>VP1077A0</td> <td>MW HINGES BALL-BEARING CARRIER</td> <td>1.000</td> <td>PC</td> </tr> </tbody> </table>		Code	Description	Qty	UOM	0H2574A0	SPEED PRO DOOR PIN BRACKET	1.000	PC	0H2918A0	SPEED PRO HINGE TIE ROD WITH WASHERS	1.000	PC	0H2919B0	SPEED.PRO SHORT SPRING BRACKET + WASHER	1.000	PC	ML1018B0	De24.4 H44 12 SPIR PULL SPRING	1.000	PC	ML1019A0	L0166 K0.38 Dm21.8 TRACTION SPRING	1.000	PC	VI1074A0	4X16 SCREW FOR PLASTIC	3.000	PC	VI1136A0	M5 UNI-1751 ST.STEEL SPRING WASHER	8.000	PC	VI1280A1	M5x10 TC1/2T SCREW	8.000	PC	VI1875A0	SCREW M5X10 TC1/2T INOX	7.000	PC	VM1524A0	D 24 d 8 B 8 MW HINGE BEARING	2.000	PC	VM1533A0	SPEED.PRO DOOR FULCRUM PIN	1.000	PC	VM1534A0	SPEED.PRO DOOR HOLDER BEARING PIN	1.000	PC	VM1570A1	SPEED.PRO RIGHT HINGE SET	1.000	PC	VP1077A0	MW HINGES BALL-BEARING CARRIER	1.000	PC
Code	Description	Qty	UOM																																																															
0H2574A0	SPEED PRO DOOR PIN BRACKET	1.000	PC																																																															
0H2918A0	SPEED PRO HINGE TIE ROD WITH WASHERS	1.000	PC																																																															
0H2919B0	SPEED.PRO SHORT SPRING BRACKET + WASHER	1.000	PC																																																															
ML1018B0	De24.4 H44 12 SPIR PULL SPRING	1.000	PC																																																															
ML1019A0	L0166 K0.38 Dm21.8 TRACTION SPRING	1.000	PC																																																															
VI1074A0	4X16 SCREW FOR PLASTIC	3.000	PC																																																															
VI1136A0	M5 UNI-1751 ST.STEEL SPRING WASHER	8.000	PC																																																															
VI1280A1	M5x10 TC1/2T SCREW	8.000	PC																																																															
VI1875A0	SCREW M5X10 TC1/2T INOX	7.000	PC																																																															
VM1524A0	D 24 d 8 B 8 MW HINGE BEARING	2.000	PC																																																															
VM1533A0	SPEED.PRO DOOR FULCRUM PIN	1.000	PC																																																															
VM1534A0	SPEED.PRO DOOR HOLDER BEARING PIN	1.000	PC																																																															
VM1570A1	SPEED.PRO RIGHT HINGE SET	1.000	PC																																																															
VP1077A0	MW HINGES BALL-BEARING CARRIER	1.000	PC																																																															





PLATON SERVICE
8 (800) 500-34-47
www.platonservice.com

COMPONENT			SPARE PART																																																			
Code	Description	Image	Code	Description	Kit components																																																	
VM1571A	SPEED.PRO LEFT HINGE SET		KVM1571A	SPEED.Pro LEFT HINGE SET	<table border="1"> <thead> <tr> <th>Code</th> <th>Description</th> <th>Qty</th> <th>UOM</th> </tr> </thead> <tbody> <tr> <td>0H2919B0</td> <td>SPEED.PRO SHORT SPRING BRACKET + WASHER</td> <td>1.000</td> <td>PC</td> </tr> <tr> <td>VI1136A0</td> <td>M5 UNI-1751 ST.STEEL SPRING WASHER</td> <td>8.000</td> <td>PC</td> </tr> <tr> <td>VI1280A1</td> <td>M5x10 TC1/2T SCREW</td> <td>8.000</td> <td>PC</td> </tr> <tr> <td>VM1571A1</td> <td>SPEED.PRO LEFT HINGE SET</td> <td>1.000</td> <td>PC</td> </tr> </tbody> </table>	Code	Description	Qty	UOM	0H2919B0	SPEED.PRO SHORT SPRING BRACKET + WASHER	1.000	PC	VI1136A0	M5 UNI-1751 ST.STEEL SPRING WASHER	8.000	PC	VI1280A1	M5x10 TC1/2T SCREW	8.000	PC	VM1571A1	SPEED.PRO LEFT HINGE SET	1.000	PC																													
			Code	Description	Qty	UOM																																																
0H2919B0	SPEED.PRO SHORT SPRING BRACKET + WASHER	1.000	PC																																																			
VI1136A0	M5 UNI-1751 ST.STEEL SPRING WASHER	8.000	PC																																																			
VI1280A1	M5x10 TC1/2T SCREW	8.000	PC																																																			
VM1571A1	SPEED.PRO LEFT HINGE SET	1.000	PC																																																			
KCR1130A	SPEED.Pro LEFT HINGE KIT	<table border="1"> <thead> <tr> <th>Code</th> <th>Description</th> <th>Qty</th> <th>UOM</th> </tr> </thead> <tbody> <tr> <td>0H2574A0</td> <td>SPEED PRO DOOR PIN BRACKET</td> <td>1.000</td> <td>PC</td> </tr> <tr> <td>0H2918A0</td> <td>SPEED PRO HINGE TIE ROD WITH WASHERS</td> <td>1.000</td> <td>PC</td> </tr> <tr> <td>0H2919B0</td> <td>SPEED.PRO SHORT SPRING BRACKET + WASHER</td> <td>1.000</td> <td>PC</td> </tr> <tr> <td>ML1018B0</td> <td>De24.4 H44 12 SPIR PULL SPRING</td> <td>1.000</td> <td>PC</td> </tr> <tr> <td>ML1019A0</td> <td>L0166 K0.38 Dm21.8 TRACTION SPRING</td> <td>1.000</td> <td>PC</td> </tr> <tr> <td>VI1074A0</td> <td>4X16 SCREW FOR PLASTIC</td> <td>3.000</td> <td>PC</td> </tr> <tr> <td>VI1136A0</td> <td>M5 UNI-1751 ST.STEEL SPRING WASHER</td> <td>8.000</td> <td>PC</td> </tr> <tr> <td>VI1280A1</td> <td>M5x10 TC1/2T SCREW</td> <td>8.000</td> <td>PC</td> </tr> <tr> <td>VI1875A0</td> <td>SCREW M5X10 TC1/2T INOX</td> <td>7.000</td> <td>PC</td> </tr> <tr> <td>VM1524A0</td> <td>D 24 d 8 B 8 MW HINGE BEARING</td> <td>2.000</td> <td>PC</td> </tr> <tr> <td>VM1533A0</td> <td>SPEED.PRO DOOR FULCRUM PIN</td> <td>1.000</td> <td>PC</td> </tr> <tr> <td>VM1534A0</td> <td>SPEED.PRO DOOR HOLDER BEARING PIN</td> <td>1.000</td> <td>PC</td> </tr> </tbody> </table>	Code	Description	Qty	UOM	0H2574A0	SPEED PRO DOOR PIN BRACKET	1.000	PC	0H2918A0	SPEED PRO HINGE TIE ROD WITH WASHERS	1.000	PC	0H2919B0	SPEED.PRO SHORT SPRING BRACKET + WASHER	1.000	PC	ML1018B0	De24.4 H44 12 SPIR PULL SPRING	1.000	PC	ML1019A0	L0166 K0.38 Dm21.8 TRACTION SPRING	1.000	PC	VI1074A0	4X16 SCREW FOR PLASTIC	3.000	PC	VI1136A0	M5 UNI-1751 ST.STEEL SPRING WASHER	8.000	PC	VI1280A1	M5x10 TC1/2T SCREW	8.000	PC	VI1875A0	SCREW M5X10 TC1/2T INOX	7.000	PC	VM1524A0	D 24 d 8 B 8 MW HINGE BEARING	2.000	PC	VM1533A0	SPEED.PRO DOOR FULCRUM PIN	1.000	PC	VM1534A0	SPEED.PRO DOOR HOLDER BEARING PIN	1.000	PC
Code	Description	Qty	UOM																																																			
0H2574A0	SPEED PRO DOOR PIN BRACKET	1.000	PC																																																			
0H2918A0	SPEED PRO HINGE TIE ROD WITH WASHERS	1.000	PC																																																			
0H2919B0	SPEED.PRO SHORT SPRING BRACKET + WASHER	1.000	PC																																																			
ML1018B0	De24.4 H44 12 SPIR PULL SPRING	1.000	PC																																																			
ML1019A0	L0166 K0.38 Dm21.8 TRACTION SPRING	1.000	PC																																																			
VI1074A0	4X16 SCREW FOR PLASTIC	3.000	PC																																																			
VI1136A0	M5 UNI-1751 ST.STEEL SPRING WASHER	8.000	PC																																																			
VI1280A1	M5x10 TC1/2T SCREW	8.000	PC																																																			
VI1875A0	SCREW M5X10 TC1/2T INOX	7.000	PC																																																			
VM1524A0	D 24 d 8 B 8 MW HINGE BEARING	2.000	PC																																																			
VM1533A0	SPEED.PRO DOOR FULCRUM PIN	1.000	PC																																																			
VM1534A0	SPEED.PRO DOOR HOLDER BEARING PIN	1.000	PC																																																			



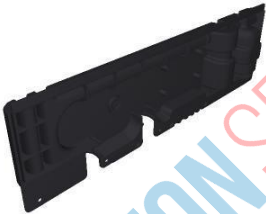

COMPONENT			SPARE PART														
Code	Description	Image	Code	Description	Kit components												
VM1571A	SPEED.PRO LEFT HINGE SET		KCR1130A	SPEED.Pro LEFT HINGE KIT	<table border="1"> <thead> <tr> <th>Code</th> <th>Description</th> <th>Qty</th> <th>UOM</th> </tr> </thead> <tbody> <tr> <td>VM1571A1</td> <td>SPEED.PRO LEFT HINGE SET</td> <td>1.000</td> <td>PC</td> </tr> <tr> <td>VP1077A0</td> <td>MW HINGES BALL-BEARING CARRIER</td> <td>1.000</td> <td>PC</td> </tr> </tbody> </table>	Code	Description	Qty	UOM	VM1571A1	SPEED.PRO LEFT HINGE SET	1.000	PC	VP1077A0	MW HINGES BALL-BEARING CARRIER	1.000	PC
Code	Description	Qty	UOM														
VM1571A1	SPEED.PRO LEFT HINGE SET	1.000	PC														
VP1077A0	MW HINGES BALL-BEARING CARRIER	1.000	PC														
VM1609A	VM1609A0		KVM1609A	SPEED.PRO MOTOR ANTI VIBRATION KIT	<table border="1"> <thead> <tr> <th>Code</th> <th>Description</th> <th>Qty</th> <th>UOM</th> </tr> </thead> <tbody> <tr> <td>V11220A1</td> <td>4,2x12 TCB SELF-TAPPING SCREW</td> <td>1.000</td> <td>PC</td> </tr> <tr> <td>VM1120A0</td> <td>CONE-SHAPE D CAP TO CLOSE Ø30 PIPE</td> <td>1.000</td> <td>PC</td> </tr> </tbody> </table>	Code	Description	Qty	UOM	V11220A1	4,2x12 TCB SELF-TAPPING SCREW	1.000	PC	VM1120A0	CONE-SHAPE D CAP TO CLOSE Ø30 PIPE	1.000	PC
Code	Description	Qty	UOM														
V11220A1	4,2x12 TCB SELF-TAPPING SCREW	1.000	PC														
VM1120A0	CONE-SHAPE D CAP TO CLOSE Ø30 PIPE	1.000	PC														
VM1631A	PLUS INNER GLASS PUSHING CAP		KVM1631A	CAP FOR INTERNAL GLASS 10 PCS KIT	<table border="1"> <thead> <tr> <th>Code</th> <th>Description</th> <th>Qty</th> <th>UOM</th> </tr> </thead> <tbody> <tr> <td>VM1631A0</td> <td>PLUS INNER GLASS PUSHING CAP</td> <td>10.000</td> <td>PC</td> </tr> </tbody> </table>	Code	Description	Qty	UOM	VM1631A0	PLUS INNER GLASS PUSHING CAP	10.000	PC				
Code	Description	Qty	UOM														
VM1631A0	PLUS INNER GLASS PUSHING CAP	10.000	PC														
VM1750A	BRASS COMB CLAMP		KVM1750A	COMB TERMINAL BLOCK KIT	<table border="1"> <thead> <tr> <th>Code</th> <th>Description</th> <th>Qty</th> <th>UOM</th> </tr> </thead> <tbody> <tr> <td>V11040A0</td> <td>INDENTED INTERNAL WASHER D=6 ZN</td> <td>2.000</td> <td>PC</td> </tr> <tr> <td>VM1750A0</td> <td>BRASS COMB CLAMP</td> <td>1.000</td> <td>PC</td> </tr> </tbody> </table>	Code	Description	Qty	UOM	V11040A0	INDENTED INTERNAL WASHER D=6 ZN	2.000	PC	VM1750A0	BRASS COMB CLAMP	1.000	PC
Code	Description	Qty	UOM														
V11040A0	INDENTED INTERNAL WASHER D=6 ZN	2.000	PC														
VM1750A0	BRASS COMB CLAMP	1.000	PC														
VM2455A	SP CONTROL BOARD CABLE PASS-THROUGH CLIP		KVM2455A	BL SP CONTROL BOARD CABLE PASS-THROUGH KIT	<table border="1"> <thead> <tr> <th>Code</th> <th>Description</th> <th>Qty</th> <th>UOM</th> </tr> </thead> <tbody> <tr> <td>VM2455A1</td> <td>SP CONTROL BOARD CABLE PASS-THROUGH CLIP</td> <td>1.000</td> <td>PC</td> </tr> </tbody> </table>	Code	Description	Qty	UOM	VM2455A1	SP CONTROL BOARD CABLE PASS-THROUGH CLIP	1.000	PC				
Code	Description	Qty	UOM														
VM2455A1	SP CONTROL BOARD CABLE PASS-THROUGH CLIP	1.000	PC														



COMPONENT			SPARE PART																						
Code	Description	Image	Code	Description	Kit components																				
VM2482A	ELECTR COMPONENTS HOLDER FRAME SHOP.PRO		KVM2482A	BAKERLUX SP ELECTR COMPONENTS HOLDER KIT	<table border="1"> <thead> <tr> <th>Code</th> <th>Description</th> <th>Qty</th> <th>UOM</th> </tr> </thead> <tbody> <tr> <td>VM2482A0</td> <td>ELECTR COMPONENT S HOLDER FRAME SHOP.PRO</td> <td>1.000</td> <td>PC</td> </tr> <tr> <td>VM2484A0</td> <td>ELECTRICAL CONNECTION CABLE CLAMP</td> <td>1.000</td> <td>PC</td> </tr> </tbody> </table>	Code	Description	Qty	UOM	VM2482A0	ELECTR COMPONENT S HOLDER FRAME SHOP.PRO	1.000	PC	VM2484A0	ELECTRICAL CONNECTION CABLE CLAMP	1.000	PC								
					Code	Description	Qty	UOM																	
VM2482A0	ELECTR COMPONENT S HOLDER FRAME SHOP.PRO	1.000	PC																						
VM2484A0	ELECTRICAL CONNECTION CABLE CLAMP	1.000	PC																						
<table border="1"> <thead> <tr> <th>Code</th> <th>Description</th> <th>Qty</th> <th>UOM</th> </tr> </thead> <tbody> <tr> <td>VM2483A1</td> <td>SHOP PRO COMPONENT S HOLDER COVER</td> <td>1.000</td> <td>PC</td> </tr> </tbody> </table>	Code	Description	Qty	UOM	VM2483A1	SHOP PRO COMPONENT S HOLDER COVER	1.000	PC																	
Code	Description	Qty	UOM																						
VM2483A1	SHOP PRO COMPONENT S HOLDER COVER	1.000	PC																						
VM2483A	SHOP PRO COMPONENTS HOLDER COVER		KVM2483A	BL SHOP.PRO COMPONENTS HOLDER COVER KIT	<table border="1"> <thead> <tr> <th>Code</th> <th>Description</th> <th>Qty</th> <th>UOM</th> </tr> </thead> <tbody> <tr> <td>VM2483A1</td> <td>SHOP PRO COMPONENT S HOLDER COVER</td> <td>1.000</td> <td>PC</td> </tr> </tbody> </table>	Code	Description	Qty	UOM	VM2483A1	SHOP PRO COMPONENT S HOLDER COVER	1.000	PC												
Code	Description	Qty	UOM																						
VM2483A1	SHOP PRO COMPONENT S HOLDER COVER	1.000	PC																						
VM2484A	ELECTRICAL CONNECTION CABLE CLAMP		KVM2484A	CABLE LOCKS ELECTRICAL CONNECTION KIT	<table border="1"> <thead> <tr> <th>Code</th> <th>Description</th> <th>Qty</th> <th>UOM</th> </tr> </thead> <tbody> <tr> <td>VM2484A0</td> <td>ELECTRICAL CONNECTION CABLE CLAMP</td> <td>1.000</td> <td>PC</td> </tr> </tbody> </table>	Code	Description	Qty	UOM	VM2484A0	ELECTRICAL CONNECTION CABLE CLAMP	1.000	PC												
					Code	Description	Qty	UOM																	
					VM2484A0	ELECTRICAL CONNECTION CABLE CLAMP	1.000	PC																	
<table border="1"> <thead> <tr> <th>Code</th> <th>Description</th> <th>Qty</th> <th>UOM</th> </tr> </thead> <tbody> <tr> <td>VM2482A0</td> <td>ELECTR COMPONENT S HOLDER FRAME SHOP.PRO</td> <td>1.000</td> <td>PC</td> </tr> </tbody> </table>	Code	Description	Qty	UOM	VM2482A0	ELECTR COMPONENT S HOLDER FRAME SHOP.PRO	1.000	PC																	
Code	Description	Qty	UOM																						
VM2482A0	ELECTR COMPONENT S HOLDER FRAME SHOP.PRO	1.000	PC																						
<table border="1"> <thead> <tr> <th>Code</th> <th>Description</th> <th>Qty</th> <th>UOM</th> </tr> </thead> <tbody> <tr> <td>VM2484A0</td> <td>ELECTRICAL CONNECTION CABLE CLAMP</td> <td>1.000</td> <td>PC</td> </tr> </tbody> </table>	Code	Description	Qty	UOM	VM2484A0	ELECTRICAL CONNECTION CABLE CLAMP	1.000	PC																	
Code	Description	Qty	UOM																						
VM2484A0	ELECTRICAL CONNECTION CABLE CLAMP	1.000	PC																						
VM2490A	460X330 SP EXT FRONT BOTTOM GASKET		KVM2490A	SP 460X330 EXT BOTTOM PANEL GASKET KIT	<table border="1"> <thead> <tr> <th>Code</th> <th>Description</th> <th>Qty</th> <th>UOM</th> </tr> </thead> <tbody> <tr> <td>VM1794A0</td> <td>250x4.8 PA66 BLACK CLAMP</td> <td>2.000</td> <td>PC</td> </tr> <tr> <td>VM2103A0</td> <td>CLAMP LOCK</td> <td>2.000</td> <td>PC</td> </tr> <tr> <td>VM2490A0</td> <td>460X330 SP EXT FRONT BOTTOM GASKET</td> <td>2.000</td> <td>PC</td> </tr> </tbody> </table>	Code	Description	Qty	UOM	VM1794A0	250x4.8 PA66 BLACK CLAMP	2.000	PC	VM2103A0	CLAMP LOCK	2.000	PC	VM2490A0	460X330 SP EXT FRONT BOTTOM GASKET	2.000	PC				
					Code	Description	Qty	UOM																	
					VM1794A0	250x4.8 PA66 BLACK CLAMP	2.000	PC																	
VM2103A0	CLAMP LOCK	2.000	PC																						
VM2490A0	460X330 SP EXT FRONT BOTTOM GASKET	2.000	PC																						
<table border="1"> <thead> <tr> <th>Code</th> <th>Description</th> <th>Qty</th> <th>UOM</th> </tr> </thead> <tbody> <tr> <td>VM1631A0</td> <td>PLUS INNER GLASS PUSHING CAP</td> <td>4.000</td> <td>PC</td> </tr> </tbody> </table>	Code	Description	Qty	UOM	VM1631A0	PLUS INNER GLASS PUSHING CAP	4.000	PC																	
Code	Description	Qty	UOM																						
VM1631A0	PLUS INNER GLASS PUSHING CAP	4.000	PC																						
<table border="1"> <thead> <tr> <th>Code</th> <th>Description</th> <th>Qty</th> <th>UOM</th> </tr> </thead> <tbody> <tr> <td>VM1794A0</td> <td>250x4.8 PA66 BLACK CLAMP</td> <td>2.000</td> <td>PC</td> </tr> <tr> <td>VM2103A0</td> <td>CLAMP LOCK</td> <td>2.000</td> <td>PC</td> </tr> <tr> <td>VM2491A1</td> <td>460X330 BLSP LATERAL BOTTOM PANEL GASKE</td> <td>2.000</td> <td>PC</td> </tr> </tbody> </table>	Code	Description	Qty	UOM	VM1794A0	250x4.8 PA66 BLACK CLAMP	2.000	PC	VM2103A0	CLAMP LOCK	2.000	PC	VM2491A1	460X330 BLSP LATERAL BOTTOM PANEL GASKE	2.000	PC									
Code	Description	Qty	UOM																						
VM1794A0	250x4.8 PA66 BLACK CLAMP	2.000	PC																						
VM2103A0	CLAMP LOCK	2.000	PC																						
VM2491A1	460X330 BLSP LATERAL BOTTOM PANEL GASKE	2.000	PC																						
VM2491A	460x330 BLSP LATERAL BOTTOM PANEL GASKET		KVM2491A	SP 460X330 LAT BOTT PANEL GASKET 2PC KIT	<table border="1"> <thead> <tr> <th>Code</th> <th>Description</th> <th>Qty</th> <th>UOM</th> </tr> </thead> <tbody> <tr> <td>VM1631A0</td> <td>PLUS INNER GLASS PUSHING CAP</td> <td>4.000</td> <td>PC</td> </tr> <tr> <td>VM1794A0</td> <td>250x4.8 PA66 BLACK CLAMP</td> <td>2.000</td> <td>PC</td> </tr> <tr> <td>VM2103A0</td> <td>CLAMP LOCK</td> <td>2.000</td> <td>PC</td> </tr> <tr> <td>VM2491A1</td> <td>460X330 BLSP LATERAL BOTTOM PANEL GASKE</td> <td>2.000</td> <td>PC</td> </tr> </tbody> </table>	Code	Description	Qty	UOM	VM1631A0	PLUS INNER GLASS PUSHING CAP	4.000	PC	VM1794A0	250x4.8 PA66 BLACK CLAMP	2.000	PC	VM2103A0	CLAMP LOCK	2.000	PC	VM2491A1	460X330 BLSP LATERAL BOTTOM PANEL GASKE	2.000	PC
Code	Description	Qty	UOM																						
VM1631A0	PLUS INNER GLASS PUSHING CAP	4.000	PC																						
VM1794A0	250x4.8 PA66 BLACK CLAMP	2.000	PC																						
VM2103A0	CLAMP LOCK	2.000	PC																						
VM2491A1	460X330 BLSP LATERAL BOTTOM PANEL GASKE	2.000	PC																						



COMPONENT			SPARE PART										
Code	Description	Image	Code	Description	Kit components								
VP1029A	VP1029A0		KVP1029A	MW BOTTOM GASKET EXTENSION KIT	<table border="1"> <thead> <tr> <th>Code</th> <th>Description</th> <th>Qty</th> <th>UOM</th> </tr> </thead> <tbody> <tr> <td>VP1029A0</td> <td>VP1029A0</td> <td>2.000</td> <td>PC</td> </tr> </tbody> </table>	Code	Description	Qty	UOM	VP1029A0	VP1029A0	2.000	PC
Code	Description	Qty	UOM										
VP1029A0	VP1029A0	2.000	PC										
VP1074A	VP1074A0		VP1074A0	VP1074A0									



PLATON SERVICE
 8 (800) 500-34-47
 www.platonservice.com

ASM3238A/0.D02 - Electrical system

FRONT

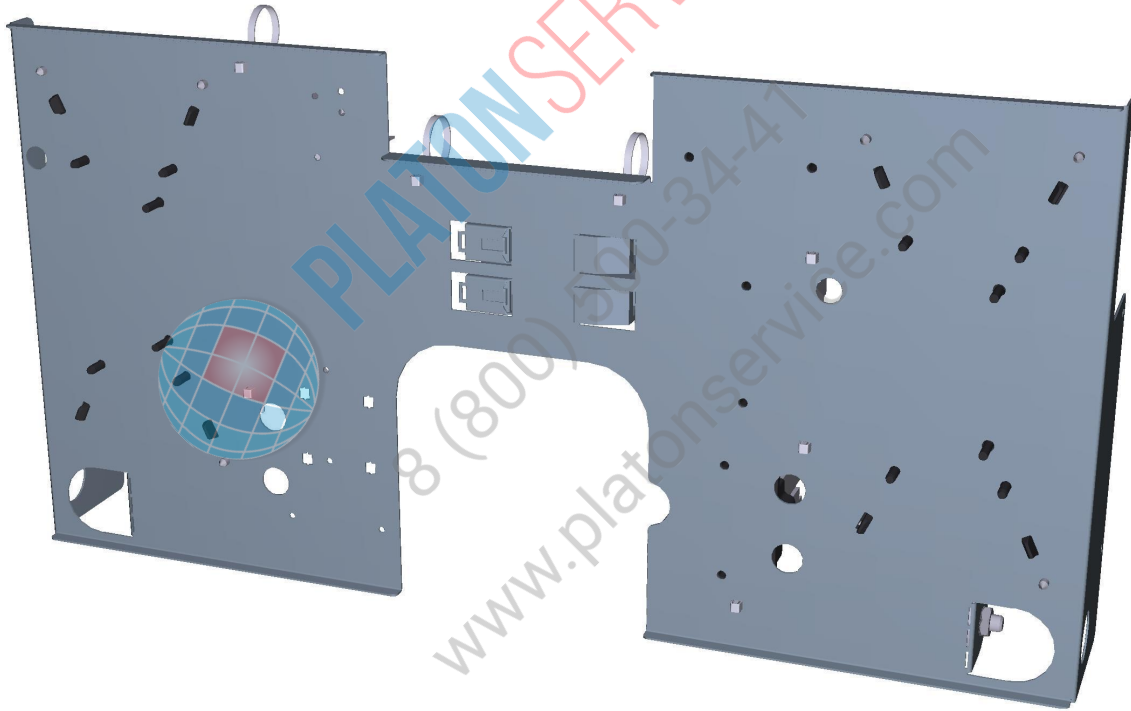



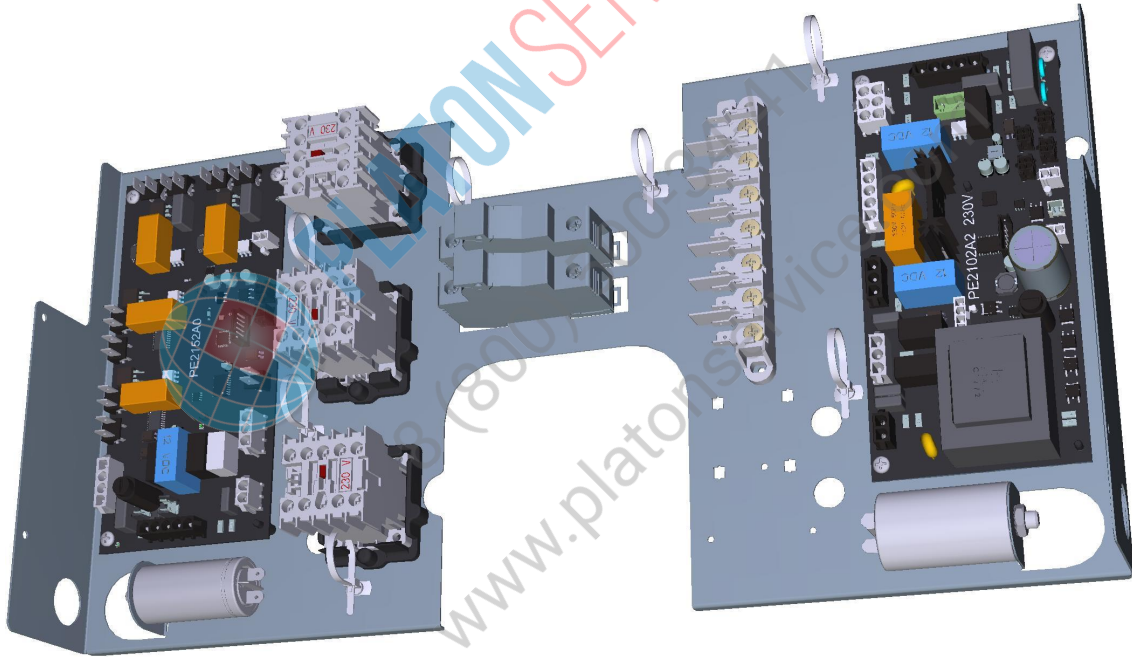

ASM3238A/0.D02 - Electrical system



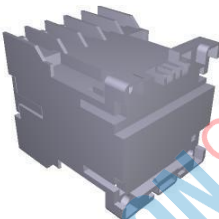

REAR





COMPONENT			SPARE PART																		
Code	Description	Image	Code	Description	Kit components																
0H5264A	MW ELECTRIC COMPONENTS HOLDER		0H5264A2	MW ELECTRIC COMPONENTS HOLDER																	
VE1115A	20 A 230V 4 POLES MINICONTACTOR		KVE1115A	20A 230V 4 POLES MINICONTACTOR KI	<table border="1"> <thead> <tr> <th>Code</th> <th>Description</th> <th>Qty</th> <th>UOM</th> </tr> </thead> <tbody> <tr> <td>VE1115A0</td> <td>20 A 230V 4 POLES MINICONTACTOR</td> <td>1.000</td> <td>PC</td> </tr> <tr> <td>VM1075A1</td> <td>PLASTIC CLIP TO FIX CONTACTORS</td> <td>4.000</td> <td>PC</td> </tr> </tbody> </table>	Code	Description	Qty	UOM	VE1115A0	20 A 230V 4 POLES MINICONTACTOR	1.000	PC	VM1075A1	PLASTIC CLIP TO FIX CONTACTORS	4.000	PC				
Code	Description	Qty	UOM																		
VE1115A0	20 A 230V 4 POLES MINICONTACTOR	1.000	PC																		
VM1075A1	PLASTIC CLIP TO FIX CONTACTORS	4.000	PC																		
VM1056A	SMALL CONTACTOR BRACKET VE1115A		VM1056A0	SMALL CONTACTOR BRACKET VE1115A																	
PE2102A	BL LED/TOUCH/PLUS 230V POWER BOAR		KPE2102A	BL LED/TOUCH/MASTE R 230V POWER CARD KIT	<table border="1"> <thead> <tr> <th>Code</th> <th>Description</th> <th>Qty</th> <th>UOM</th> </tr> </thead> <tbody> <tr> <td>PE2102A2</td> <td>BL LED/TOUCH/PLUS 230V POWER BOAR</td> <td>1.000</td> <td>PC</td> </tr> <tr> <td>V11988A0</td> <td>AUTOTHREADING SCREW 4,2x19 TCB+ INOX</td> <td>3.000</td> <td>PC</td> </tr> <tr> <td>VM1187A0</td> <td>POWER BOARD FRAME SHOP.PRO</td> <td>1.000</td> <td>PC</td> </tr> </tbody> </table>	Code	Description	Qty	UOM	PE2102A2	BL LED/TOUCH/PLUS 230V POWER BOAR	1.000	PC	V11988A0	AUTOTHREADING SCREW 4,2x19 TCB+ INOX	3.000	PC	VM1187A0	POWER BOARD FRAME SHOP.PRO	1.000	PC
Code	Description	Qty	UOM																		
PE2102A2	BL LED/TOUCH/PLUS 230V POWER BOAR	1.000	PC																		
V11988A0	AUTOTHREADING SCREW 4,2x19 TCB+ INOX	3.000	PC																		
VM1187A0	POWER BOARD FRAME SHOP.PRO	1.000	PC																		
VM1187A	POWER BOARD FRAME SHOP.PRO		VM1187A0	POWER BOARD FRAME SHOP.PRO																	

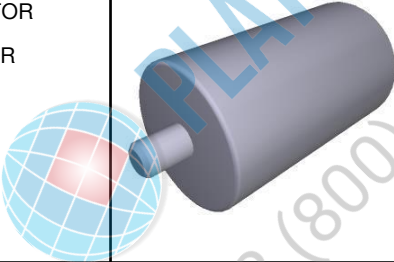

COMPONENT			SPARE PART																		
Code	Description	Image	Code	Description	Kit components																
PE2152A	MW MAGNETRON POWER BOARD		KPE2152A	MAGNETRON MW POWER BOARD KIT	<table border="1"> <thead> <tr> <th>Code</th> <th>Description</th> <th>Qty</th> <th>UOM</th> </tr> </thead> <tbody> <tr> <td>PE2152A0</td> <td>MW MAGNETRON POWER BOAR</td> <td>1.000</td> <td>PC</td> </tr> <tr> <td>VI1988A0</td> <td>AUTOTHREAD ING SCREW 4,2x19 TCB+ INOX</td> <td>3.000</td> <td>PC</td> </tr> </tbody> </table>	Code	Description	Qty	UOM	PE2152A0	MW MAGNETRON POWER BOAR	1.000	PC	VI1988A0	AUTOTHREAD ING SCREW 4,2x19 TCB+ INOX	3.000	PC				
Code	Description	Qty	UOM																		
PE2152A0	MW MAGNETRON POWER BOAR	1.000	PC																		
VI1988A0	AUTOTHREAD ING SCREW 4,2x19 TCB+ INOX	3.000	PC																		
VM1187A	POWER BOARD FRAME SHOP.PRO		VM1187A0	POWER BOARD FRAME SHOP.PRO																	
CN1003A	6,3 Uf MOTOR CAPACITOR		KCN1003A	6,3 uF MOTOR CAPACITOR KIT	<table border="1"> <thead> <tr> <th>Code</th> <th>Description</th> <th>Qty</th> <th>UOM</th> </tr> </thead> <tbody> <tr> <td>CN1003A0</td> <td>6,3 Uf MOTOR CAPACITOR</td> <td>1.000</td> <td>PC</td> </tr> <tr> <td>VI1931A0</td> <td>M8x1.65 H4 CH13 ZINC PLATED NUT</td> <td>1.000</td> <td>PC</td> </tr> <tr> <td>VI1932A0</td> <td>D8 INDENTED ZINC PLATED WASHER</td> <td>1.000</td> <td>PC</td> </tr> </tbody> </table>	Code	Description	Qty	UOM	CN1003A0	6,3 Uf MOTOR CAPACITOR	1.000	PC	VI1931A0	M8x1.65 H4 CH13 ZINC PLATED NUT	1.000	PC	VI1932A0	D8 INDENTED ZINC PLATED WASHER	1.000	PC
Code	Description	Qty	UOM																		
CN1003A0	6,3 Uf MOTOR CAPACITOR	1.000	PC																		
VI1931A0	M8x1.65 H4 CH13 ZINC PLATED NUT	1.000	PC																		
VI1932A0	D8 INDENTED ZINC PLATED WASHER	1.000	PC																		
CN1010A	MOTOR CAPACITOR 3,5µF 450V,CE/UL,P CLASS		KCN1010A	3.5UF MOTOR CAPACITOR KIT	<table border="1"> <thead> <tr> <th>Code</th> <th>Description</th> <th>Qty</th> <th>UOM</th> </tr> </thead> <tbody> <tr> <td>CN1010A0</td> <td>MOTOR CAPACITOR 3,5µF 450V,CE/UL,P CLASS</td> <td>1.000</td> <td>PC</td> </tr> <tr> <td>VI1931A0</td> <td>M8x1.65 H4 CH13 ZINC PLATED NUT</td> <td>1.000</td> <td>PC</td> </tr> <tr> <td>VI1932A0</td> <td>D8 INDENTED ZINC PLATED WASHER</td> <td>1.000</td> <td>PC</td> </tr> </tbody> </table>	Code	Description	Qty	UOM	CN1010A0	MOTOR CAPACITOR 3,5µF 450V,CE/UL,P CLASS	1.000	PC	VI1931A0	M8x1.65 H4 CH13 ZINC PLATED NUT	1.000	PC	VI1932A0	D8 INDENTED ZINC PLATED WASHER	1.000	PC
Code	Description	Qty	UOM																		
CN1010A0	MOTOR CAPACITOR 3,5µF 450V,CE/UL,P CLASS	1.000	PC																		
VI1931A0	M8x1.65 H4 CH13 ZINC PLATED NUT	1.000	PC																		
VI1932A0	D8 INDENTED ZINC PLATED WASHER	1.000	PC																		
MR1004A	41A 450V 7 POLES TERMINAL		KMR1004A	7FTW 1+2+3/4+5+6 TERMINAL BLOCK KIT	<table border="1"> <thead> <tr> <th>Code</th> <th>Description</th> <th>Qty</th> <th>UOM</th> </tr> </thead> <tbody> <tr> <td>MR1004A1</td> <td>41A 450V 7 POLES TERMINAL</td> <td>1.000</td> <td>PC</td> </tr> </tbody> </table>	Code	Description	Qty	UOM	MR1004A1	41A 450V 7 POLES TERMINAL	1.000	PC								
Code	Description	Qty	UOM																		
MR1004A1	41A 450V 7 POLES TERMINAL	1.000	PC																		



COMPONENT			SPARE PART										
Code	Description	Image	Code	Description	Kit components								
VE1632A	MONOPOL SECTION FUSE HOLDER 10x38 32A		KVE1632A	10x38 32A FUSE HOLDER KIT	<table border="1"> <thead> <tr> <th>Code</th> <th>Description</th> <th>Qty</th> <th>UOM</th> </tr> </thead> <tbody> <tr> <td>VE1632A0</td> <td>MONOPOL SECTION FUSE HOLDER 10x38 32A</td> <td>1.000</td> <td>PC</td> </tr> </tbody> </table>	Code	Description	Qty	UOM	VE1632A0	MONOPOL SECTION FUSE HOLDER 10x38 32A	1.000	PC
Code	Description	Qty	UOM										
VE1632A0	MONOPOL SECTION FUSE HOLDER 10x38 32A	1.000	PC										



PLATON SERVICE
 8 (800) 500-34-47
 www.platonservice.com



ASM3244A/0.D01 - Electrical system

FRONT

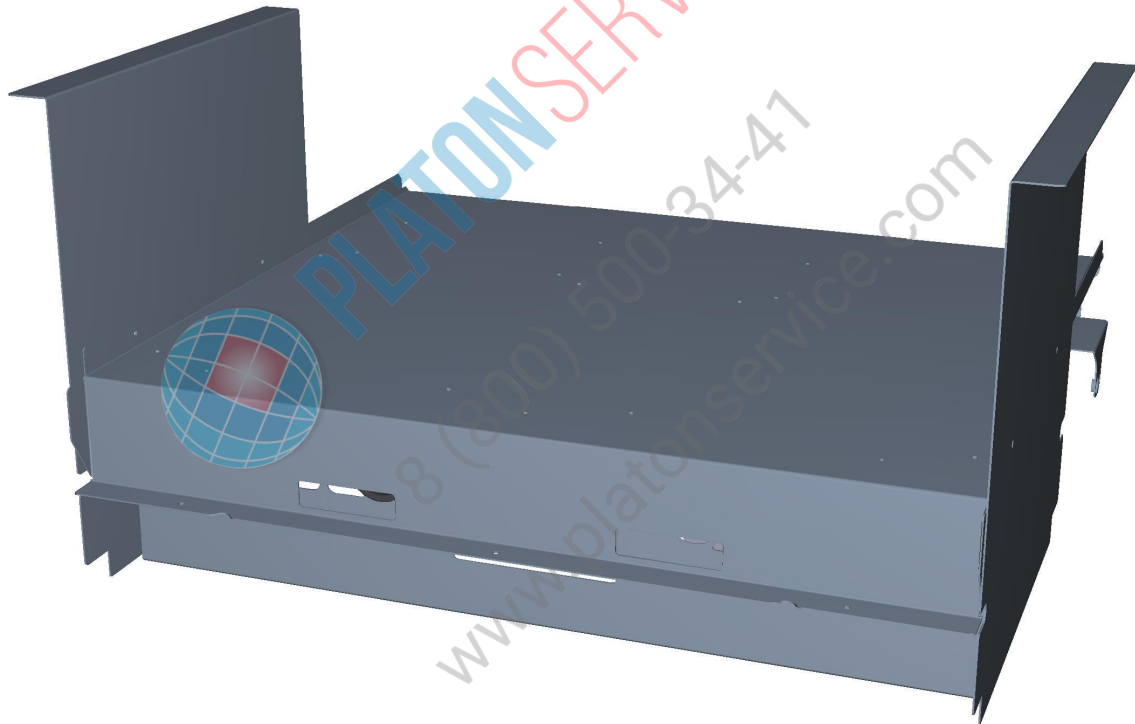



ASM3244A/0.D01 - Electrical system

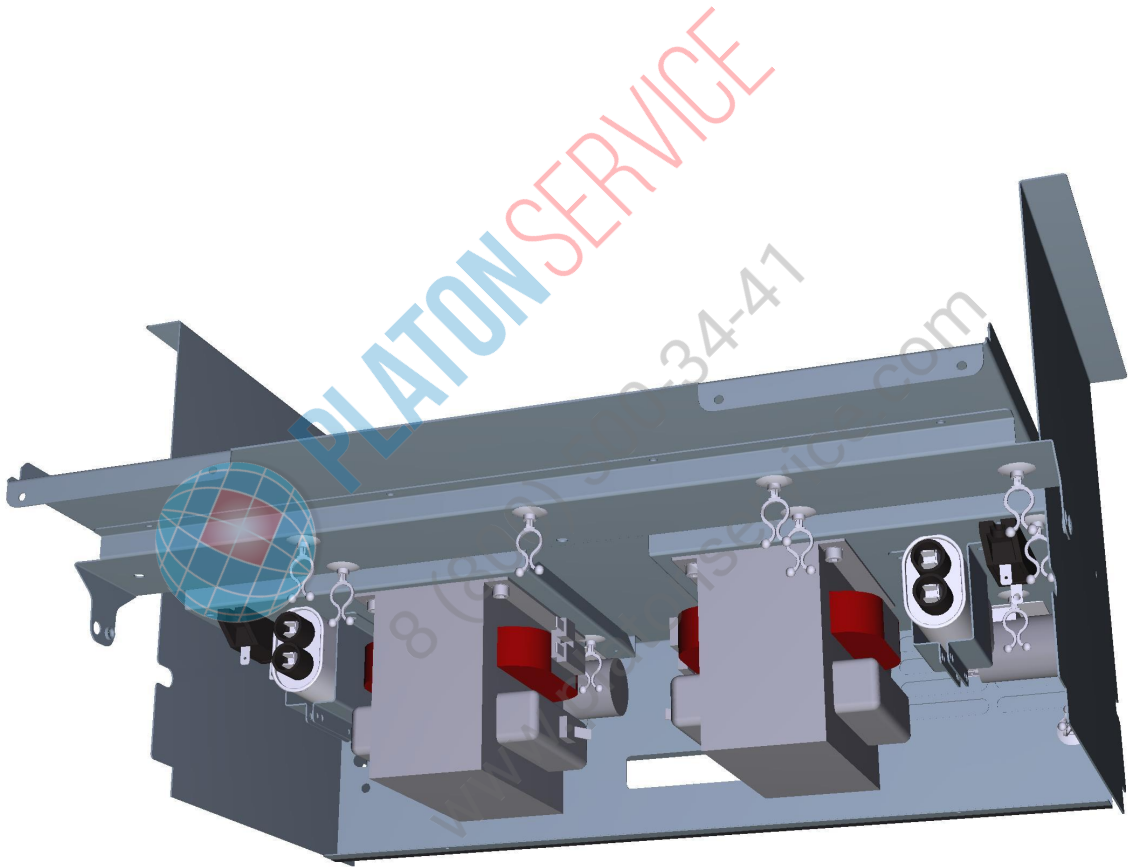

REAR

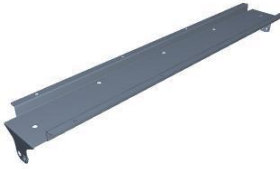
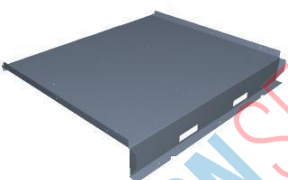
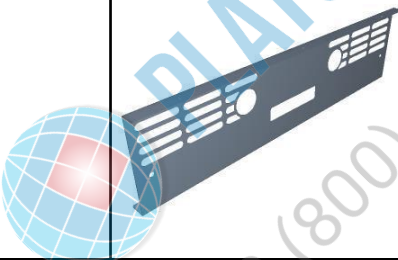



COMPONENT			SPARE PART		
Code	Description	Image	Code	Description	Kit components
0H2828A	0H2828A0		0H2828A0	0H2828A0	
0H5261B	0H5261B0		0H5261B0	0H5261B0	
0H5275B	0H5275B0		0H5275B0	0H5275B0	
0H5287A	0H5287A0		0H5287A0	0H5287A0	
0H5276A	0H5276A1		0H5276A1	0H5276A1	

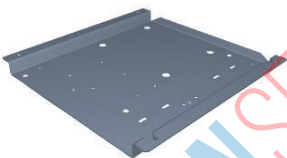

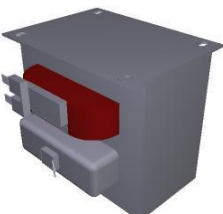
COMPONENT			SPARE PART										
Code	Description	Image	Code	Description	Kit components								
0H5281A	0H5281A0		0H5281A0	0H5281A0									
0H5282A	0H5282A0		0H5282A0	0H5282A0									
CN1015A	2500V 0.85uF HV CAPACITOR		KCN1015A	HV 2500V 0.85uF MW CONDENSER KIT	<table border="1"> <thead> <tr> <th>Code</th> <th>Description</th> <th>Qty</th> <th>UOM</th> </tr> </thead> <tbody> <tr> <td>CN1015A0</td> <td>2500V 0.85uF HV CAPACITO</td> <td>2.000</td> <td>PC</td> </tr> </tbody> </table>	Code	Description	Qty	UOM	CN1015A0	2500V 0.85uF HV CAPACITO	2.000	PC
Code	Description	Qty	UOM										
CN1015A0	2500V 0.85uF HV CAPACITO	2.000	PC										
CN1062A	CN1062A0		KCN1062A	2500V 0.62uF HV CAPACITOR KIT	<table border="1"> <thead> <tr> <th>Code</th> <th>Description</th> <th>Qty</th> <th>UOM</th> </tr> </thead> <tbody> <tr> <td>CN1062A0</td> <td>CN1062A0</td> <td>2.000</td> <td>PC</td> </tr> </tbody> </table>	Code	Description	Qty	UOM	CN1062A0	CN1062A0	2.000	PC
Code	Description	Qty	UOM										
CN1062A0	CN1062A0	2.000	PC										
VE1805B	TRANSFORMER HV 230/2270/3.2V 1000V		KVE1805B	MW 1000VA HV TRANSFORMER KIT	<table border="1"> <thead> <tr> <th>Code</th> <th>Description</th> <th>Qty</th> <th>UOM</th> </tr> </thead> <tbody> <tr> <td>VE1805B0</td> <td>TRANSFORME R HV 230/2270/3.2V 1000VA</td> <td>1.000</td> <td>PC</td> </tr> </tbody> </table>	Code	Description	Qty	UOM	VE1805B0	TRANSFORME R HV 230/2270/3.2V 1000VA	1.000	PC
Code	Description	Qty	UOM										
VE1805B0	TRANSFORME R HV 230/2270/3.2V 1000VA	1.000	PC										



COMPONENT			SPARE PART										
Code	Description	Image	Code	Description	Kit components								
VE1810A	750mAmp 16kV HIGH VOLTAGE DIODE		KVE1810A	SPEED.Pro HV DIODE KIT	<table border="1"> <thead> <tr> <th>Code</th> <th>Description</th> <th>Qty</th> <th>UOM</th> </tr> </thead> <tbody> <tr> <td>VE1810A0</td> <td>750mAmp 16kV HIGH VOLTAGE DIODE</td> <td>1.000</td> <td>PC</td> </tr> </tbody> </table>	Code	Description	Qty	UOM	VE1810A0	750mAmp 16kV HIGH VOLTAGE DIODE	1.000	PC
Code	Description	Qty	UOM										
VE1810A0	750mAmp 16kV HIGH VOLTAGE DIODE	1.000	PC										
VE1816A	2x0.47UF 16AMP CILINDIRC EMI FILTER		KVE1816A	SPEED.Pro 16AMP EMI FILTER KIT	<table border="1"> <thead> <tr> <th>Code</th> <th>Description</th> <th>Qty</th> <th>UOM</th> </tr> </thead> <tbody> <tr> <td>VE1816A0</td> <td>2x0.47UF 16AMP CILINDIRC EMI FILTER</td> <td>1.000</td> <td>PC</td> </tr> </tbody> </table>	Code	Description	Qty	UOM	VE1816A0	2x0.47UF 16AMP CILINDIRC EMI FILTER	1.000	PC
Code	Description	Qty	UOM										
VE1816A0	2x0.47UF 16AMP CILINDIRC EMI FILTER	1.000	PC										
VI0502A	SPEED.Pro 16AMP EMI FILTER KIT		VI0502A1	SPEED.Pro 16AMP EMI FILTER KIT									
VI1113A	ST.STEEL TCEI M6X12 SCREW		VI1113A0	ST.STEEL TCEI M6X12 SCREW									
GN1681A	GN1681A0		GN1681A0	GN1681A0									

ASM3274A/0.D00 - Door



FRONT

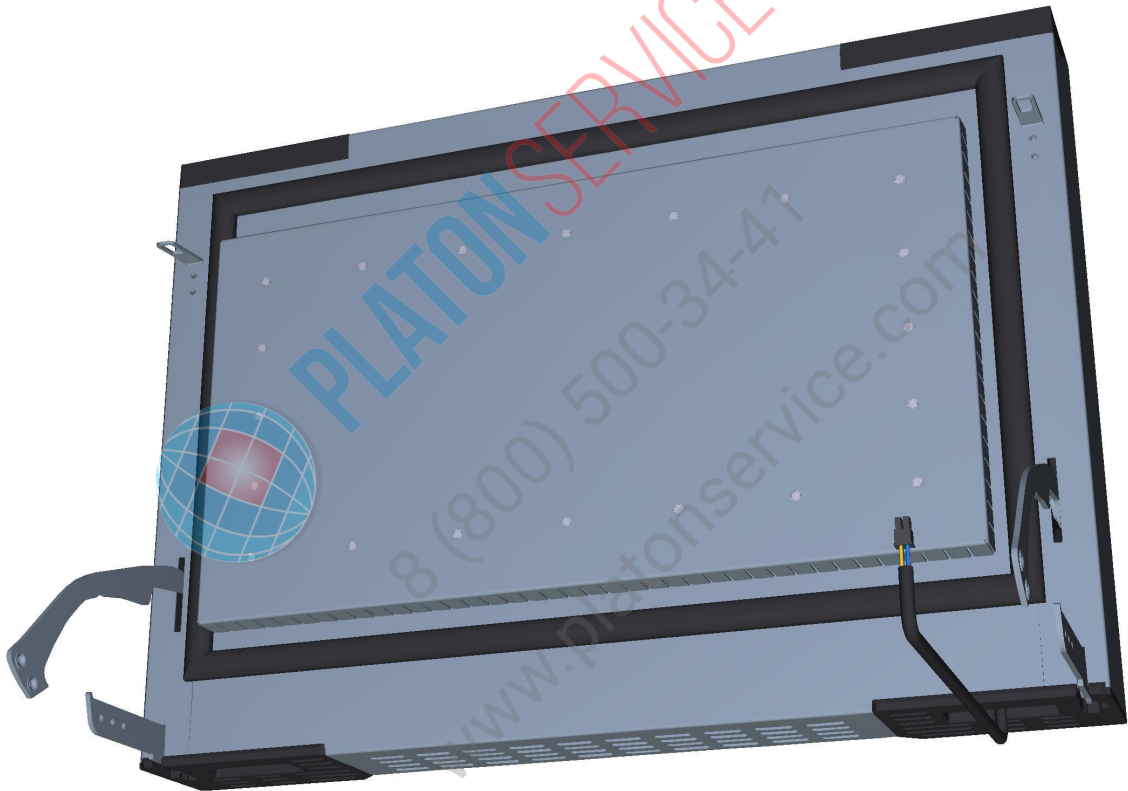

ASM3274A/0.D00 - Door

REAR

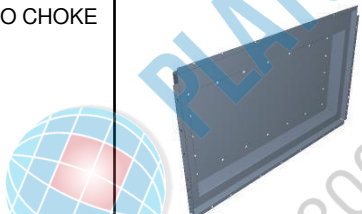

COMPONENT			SPARE PART																																																		
Code	Description	Image	Code	Description	Kit components																																																
0H5265A	SPEED.PRO DOOR FRONT PLATE		0H5265A1	SPEED.PRO DOOR FRONT PLATE																																																	
0H5272A	SPEED.PRO DOOR MICROSWITCHES HOOK		K0H5272A	MW DOOR MICROSWITCH HOOK KIT	<table border="1"> <thead> <tr> <th>Code</th> <th>Description</th> <th>Qty</th> <th>UOM</th> </tr> </thead> <tbody> <tr> <td>0H5272A1</td> <td>SPEED.PRO DOOR MICROSWITC HES HOOK</td> <td>2.000</td> <td>PC</td> </tr> <tr> <td>V11220A1</td> <td>4.2x12 TCB SELF-TAPPIN G SCREW</td> <td>4.000</td> <td>PC</td> </tr> </tbody> </table>	Code	Description	Qty	UOM	0H5272A1	SPEED.PRO DOOR MICROSWITC HES HOOK	2.000	PC	V11220A1	4.2x12 TCB SELF-TAPPIN G SCREW	4.000	PC																																				
Code	Description	Qty	UOM																																																		
0H5272A1	SPEED.PRO DOOR MICROSWITC HES HOOK	2.000	PC																																																		
V11220A1	4.2x12 TCB SELF-TAPPIN G SCREW	4.000	PC																																																		
0H2689C	SPEED.PRO CHOKE PRE SET		KDR1370A	SPEED.Pro COMPLETE DROPDOWN DOOR KIT	<table border="1"> <thead> <tr> <th>Code</th> <th>Description</th> <th>Qty</th> <th>UOM</th> </tr> </thead> <tbody> <tr> <td>0H2574A0</td> <td>SPEED PRO DOOR PIN BRACKET</td> <td>2.000</td> <td>PC</td> </tr> <tr> <td>0H2689C0</td> <td>SPEED.PRO CHOKE PRE SET</td> <td>1.000</td> <td>PC</td> </tr> <tr> <td>0H2918A0</td> <td>SPEED PRO HINGE TIE ROD WITH WASHERS</td> <td>2.000</td> <td>PC</td> </tr> <tr> <td>0H4434A1</td> <td>SPEED.Pro DOOR CHOKE WITH PINS</td> <td>1.000</td> <td>PC</td> </tr> <tr> <td>0H5265A1</td> <td>SPEED.PRO DOOR FRONT PLATE</td> <td>1.000</td> <td>PC</td> </tr> <tr> <td>0H5269A1</td> <td>SPEED.PRO DOOR GLASS WOOL PARTITION</td> <td>1.000</td> <td>PC</td> </tr> <tr> <td>0H5270A1</td> <td>SPEED.PRO DOOR PARTITION</td> <td>1.000</td> <td>PC</td> </tr> <tr> <td>0H5272A1</td> <td>SPEED.PRO DOOR MICROSWITC HES HOOK</td> <td>2.000</td> <td>PC</td> </tr> <tr> <td>CE1053B0</td> <td>MM MICROFIT LED BAR POWER SUPPLY CABL</td> <td>1.000</td> <td>PC</td> </tr> <tr> <td>GN1432B1</td> <td>GN1432B1</td> <td>1.000</td> <td>PC</td> </tr> <tr> <td>GN1682A0</td> <td>SPEED.PRO LED GASKET</td> <td>1.000</td> <td>PC</td> </tr> </tbody> </table>	Code	Description	Qty	UOM	0H2574A0	SPEED PRO DOOR PIN BRACKET	2.000	PC	0H2689C0	SPEED.PRO CHOKE PRE SET	1.000	PC	0H2918A0	SPEED PRO HINGE TIE ROD WITH WASHERS	2.000	PC	0H4434A1	SPEED.Pro DOOR CHOKE WITH PINS	1.000	PC	0H5265A1	SPEED.PRO DOOR FRONT PLATE	1.000	PC	0H5269A1	SPEED.PRO DOOR GLASS WOOL PARTITION	1.000	PC	0H5270A1	SPEED.PRO DOOR PARTITION	1.000	PC	0H5272A1	SPEED.PRO DOOR MICROSWITC HES HOOK	2.000	PC	CE1053B0	MM MICROFIT LED BAR POWER SUPPLY CABL	1.000	PC	GN1432B1	GN1432B1	1.000	PC	GN1682A0	SPEED.PRO LED GASKET	1.000	PC
Code	Description	Qty	UOM																																																		
0H2574A0	SPEED PRO DOOR PIN BRACKET	2.000	PC																																																		
0H2689C0	SPEED.PRO CHOKE PRE SET	1.000	PC																																																		
0H2918A0	SPEED PRO HINGE TIE ROD WITH WASHERS	2.000	PC																																																		
0H4434A1	SPEED.Pro DOOR CHOKE WITH PINS	1.000	PC																																																		
0H5265A1	SPEED.PRO DOOR FRONT PLATE	1.000	PC																																																		
0H5269A1	SPEED.PRO DOOR GLASS WOOL PARTITION	1.000	PC																																																		
0H5270A1	SPEED.PRO DOOR PARTITION	1.000	PC																																																		
0H5272A1	SPEED.PRO DOOR MICROSWITC HES HOOK	2.000	PC																																																		
CE1053B0	MM MICROFIT LED BAR POWER SUPPLY CABL	1.000	PC																																																		
GN1432B1	GN1432B1	1.000	PC																																																		
GN1682A0	SPEED.PRO LED GASKET	1.000	PC																																																		





COMPONENT			SPARE PART																																																																																						
Code	Description	Image	Code	Description	Kit components																																																																																				
0H2689C	SPEED.PRO CHOKE PRE SET		KDR1370A	SPEED.Pro COMPLETE DROPDOWN DOOR KIT	<table border="1"> <thead> <tr> <th>Code</th> <th>Description</th> <th>Qty</th> <th>UOM</th> </tr> </thead> <tbody> <tr> <td>LP1055A0</td> <td>SPEED PRO RGB LED BAR</td> <td>1.000</td> <td>PC</td> </tr> <tr> <td>TB2843A0</td> <td>MW HANDLE TUBE</td> <td>1.000</td> <td>PC</td> </tr> <tr> <td>VI1074A0</td> <td>4X16 SCREW FOR PLASTIC</td> <td>14.000</td> <td>PC</td> </tr> <tr> <td>VI1220A1</td> <td>4,2x12 TCB SELF-TAPPIN G SCREW</td> <td>1.000</td> <td>PC</td> </tr> <tr> <td>VI1960A1</td> <td>4.2X9.5 CROSS ZN-NI SELF-THREADI NG SCREW</td> <td>18.000</td> <td>PC</td> </tr> <tr> <td>VI2003A0</td> <td>ANTI-ROTATIO N M5X0.8 H6 ZN NUT</td> <td>20.000</td> <td>PC</td> </tr> <tr> <td>VI2037A1</td> <td>40X8 TORX SHEETTRACS SELF-THREAD SCREW</td> <td>3.000</td> <td>PC</td> </tr> <tr> <td>VI2043A0</td> <td>5X40 ST. STEEL SCREW FOR PLASTIC</td> <td>4.000</td> <td>PC</td> </tr> <tr> <td>VM1524A0</td> <td>D 24 d 8 B 8 MW HINGE BEARING</td> <td>4.000</td> <td>PC</td> </tr> <tr> <td>VM1533A0</td> <td>SPEED.PRO DOOR FULCRUM PIN</td> <td>2.000</td> <td>PC</td> </tr> <tr> <td>VM1534A0</td> <td>SPEED.PRO DOOR HOLDER BEARING PIN</td> <td>2.000</td> <td>PC</td> </tr> <tr> <td>VM2456A0</td> <td>BAKERLUX SHOP.PRO HANDLE END</td> <td>1.000</td> <td>PC</td> </tr> <tr> <td>VM2489A0</td> <td>SP HANDLE END KIT + STYLUS KIT</td> <td>1.000</td> <td>PC</td> </tr> <tr> <td>VM2527A0</td> <td>STYLUS PEN FOR SP</td> <td>1.000</td> <td>PC</td> </tr> <tr> <td>VP1022A0</td> <td>MW DOOR LEFT UPPER CAP</td> <td>1.000</td> <td>PC</td> </tr> <tr> <td>VP1023A0</td> <td>MW DOOR RIGHT UPPER CAP</td> <td>1.000</td> <td>PC</td> </tr> <tr> <td>VP1024A0</td> <td>MW DOOR LEFT LOWER CAP</td> <td>1.000</td> <td>PC</td> </tr> <tr> <td>VP1025A0</td> <td>MW DOOR RIGHT LOWER CAP</td> <td>1.000</td> <td>PC</td> </tr> <tr> <td>VP1026A0</td> <td>MW LED COVE</td> <td>1.000</td> <td>PC</td> </tr> <tr> <td>VP1077A0</td> <td>MW HINGES BALL-BEARIN G CARRIER</td> <td>2.000</td> <td>PC</td> </tr> </tbody> </table>	Code	Description	Qty	UOM	LP1055A0	SPEED PRO RGB LED BAR	1.000	PC	TB2843A0	MW HANDLE TUBE	1.000	PC	VI1074A0	4X16 SCREW FOR PLASTIC	14.000	PC	VI1220A1	4,2x12 TCB SELF-TAPPIN G SCREW	1.000	PC	VI1960A1	4.2X9.5 CROSS ZN-NI SELF-THREADI NG SCREW	18.000	PC	VI2003A0	ANTI-ROTATIO N M5X0.8 H6 ZN NUT	20.000	PC	VI2037A1	40X8 TORX SHEETTRACS SELF-THREAD SCREW	3.000	PC	VI2043A0	5X40 ST. STEEL SCREW FOR PLASTIC	4.000	PC	VM1524A0	D 24 d 8 B 8 MW HINGE BEARING	4.000	PC	VM1533A0	SPEED.PRO DOOR FULCRUM PIN	2.000	PC	VM1534A0	SPEED.PRO DOOR HOLDER BEARING PIN	2.000	PC	VM2456A0	BAKERLUX SHOP.PRO HANDLE END	1.000	PC	VM2489A0	SP HANDLE END KIT + STYLUS KIT	1.000	PC	VM2527A0	STYLUS PEN FOR SP	1.000	PC	VP1022A0	MW DOOR LEFT UPPER CAP	1.000	PC	VP1023A0	MW DOOR RIGHT UPPER CAP	1.000	PC	VP1024A0	MW DOOR LEFT LOWER CAP	1.000	PC	VP1025A0	MW DOOR RIGHT LOWER CAP	1.000	PC	VP1026A0	MW LED COVE	1.000	PC	VP1077A0	MW HINGES BALL-BEARIN G CARRIER	2.000	PC
					Code	Description	Qty	UOM																																																																																	
					LP1055A0	SPEED PRO RGB LED BAR	1.000	PC																																																																																	
					TB2843A0	MW HANDLE TUBE	1.000	PC																																																																																	
					VI1074A0	4X16 SCREW FOR PLASTIC	14.000	PC																																																																																	
					VI1220A1	4,2x12 TCB SELF-TAPPIN G SCREW	1.000	PC																																																																																	
					VI1960A1	4.2X9.5 CROSS ZN-NI SELF-THREADI NG SCREW	18.000	PC																																																																																	
					VI2003A0	ANTI-ROTATIO N M5X0.8 H6 ZN NUT	20.000	PC																																																																																	
					VI2037A1	40X8 TORX SHEETTRACS SELF-THREAD SCREW	3.000	PC																																																																																	
					VI2043A0	5X40 ST. STEEL SCREW FOR PLASTIC	4.000	PC																																																																																	
					VM1524A0	D 24 d 8 B 8 MW HINGE BEARING	4.000	PC																																																																																	
					VM1533A0	SPEED.PRO DOOR FULCRUM PIN	2.000	PC																																																																																	
					VM1534A0	SPEED.PRO DOOR HOLDER BEARING PIN	2.000	PC																																																																																	
					VM2456A0	BAKERLUX SHOP.PRO HANDLE END	1.000	PC																																																																																	
					VM2489A0	SP HANDLE END KIT + STYLUS KIT	1.000	PC																																																																																	
					VM2527A0	STYLUS PEN FOR SP	1.000	PC																																																																																	
					VP1022A0	MW DOOR LEFT UPPER CAP	1.000	PC																																																																																	
					VP1023A0	MW DOOR RIGHT UPPER CAP	1.000	PC																																																																																	
					VP1024A0	MW DOOR LEFT LOWER CAP	1.000	PC																																																																																	
					VP1025A0	MW DOOR RIGHT LOWER CAP	1.000	PC																																																																																	
VP1026A0	MW LED COVE	1.000	PC																																																																																						
VP1077A0	MW HINGES BALL-BEARIN G CARRIER	2.000	PC																																																																																						



COMPONENT			SPARE PART																																																																														
Code	Description	Image	Code	Description	Kit components																																																																												
0H4434A	SPEED.Pro DOOR CHOKE WITH PINS		KDR1370A	SPEED.Pro COMPLETE DROPDOWN DOOR KIT	<table border="1"> <thead> <tr> <th>Code</th> <th>Description</th> <th>Qty</th> <th>UOM</th> </tr> </thead> <tbody> <tr> <td>0H2574A0</td> <td>SPEED PRO DOOR PIN BRACKET</td> <td>2.000</td> <td>PC</td> </tr> <tr> <td>0H2689C0</td> <td>SPEED.PRO CHOKE PRE SET</td> <td>1.000</td> <td>PC</td> </tr> <tr> <td>0H2918A0</td> <td>SPEED PRO HINGE TIE ROD WITH WASHERS</td> <td>2.000</td> <td>PC</td> </tr> <tr> <td>0H4434A1</td> <td>SPEED.Pro DOOR CHOKE WITH PINS</td> <td>1.000</td> <td>PC</td> </tr> <tr> <td>0H5265A1</td> <td>SPEED.PRO DOOR FRONT PLATE</td> <td>1.000</td> <td>PC</td> </tr> <tr> <td>0H5269A1</td> <td>SPEED.PRO DOOR GLASS WOOL PARTITION</td> <td>1.000</td> <td>PC</td> </tr> <tr> <td>0H5270A1</td> <td>SPEED.PRO DOOR PARTITION</td> <td>1.000</td> <td>PC</td> </tr> <tr> <td>0H5272A1</td> <td>SPEED.PRO DOOR MICROSWITC HES HOOK</td> <td>2.000</td> <td>PC</td> </tr> <tr> <td>CE1053B0</td> <td>MM MICROFIT LED BAR POWER SUPPLY CABL</td> <td>1.000</td> <td>PC</td> </tr> <tr> <td>GN1432B1</td> <td>GN1432B1</td> <td>1.000</td> <td>PC</td> </tr> <tr> <td>GN1682A0</td> <td>SPEED.PRO LED GASKET</td> <td>1.000</td> <td>PC</td> </tr> <tr> <td>LP1055A0</td> <td>SPEED PRO RGB LED BAR</td> <td>1.000</td> <td>PC</td> </tr> <tr> <td>TB2843A0</td> <td>MW HANDLE TUBE</td> <td>1.000</td> <td>PC</td> </tr> <tr> <td>VI1074A0</td> <td>4X16 SCREW FOR PLASTIC</td> <td>14.000</td> <td>PC</td> </tr> <tr> <td>VI1220A1</td> <td>4,2x12 TCB SELF-TAPPIN G SCREW</td> <td>1.000</td> <td>PC</td> </tr> <tr> <td>VI1960A1</td> <td>4.2X9.5 CROSS ZN-NI SELF-THREADI NG SCREW</td> <td>18.000</td> <td>PC</td> </tr> <tr> <td>VI2003A0</td> <td>ANTI-ROTATIO N M5X0.8 H6 ZN NUT</td> <td>20.000</td> <td>PC</td> </tr> <tr> <td>VI2037A1</td> <td>40X8 TORX SHEETTRACS SELF-THREAD SCREW</td> <td>3.000</td> <td>PC</td> </tr> </tbody> </table>	Code	Description	Qty	UOM	0H2574A0	SPEED PRO DOOR PIN BRACKET	2.000	PC	0H2689C0	SPEED.PRO CHOKE PRE SET	1.000	PC	0H2918A0	SPEED PRO HINGE TIE ROD WITH WASHERS	2.000	PC	0H4434A1	SPEED.Pro DOOR CHOKE WITH PINS	1.000	PC	0H5265A1	SPEED.PRO DOOR FRONT PLATE	1.000	PC	0H5269A1	SPEED.PRO DOOR GLASS WOOL PARTITION	1.000	PC	0H5270A1	SPEED.PRO DOOR PARTITION	1.000	PC	0H5272A1	SPEED.PRO DOOR MICROSWITC HES HOOK	2.000	PC	CE1053B0	MM MICROFIT LED BAR POWER SUPPLY CABL	1.000	PC	GN1432B1	GN1432B1	1.000	PC	GN1682A0	SPEED.PRO LED GASKET	1.000	PC	LP1055A0	SPEED PRO RGB LED BAR	1.000	PC	TB2843A0	MW HANDLE TUBE	1.000	PC	VI1074A0	4X16 SCREW FOR PLASTIC	14.000	PC	VI1220A1	4,2x12 TCB SELF-TAPPIN G SCREW	1.000	PC	VI1960A1	4.2X9.5 CROSS ZN-NI SELF-THREADI NG SCREW	18.000	PC	VI2003A0	ANTI-ROTATIO N M5X0.8 H6 ZN NUT	20.000	PC	VI2037A1	40X8 TORX SHEETTRACS SELF-THREAD SCREW	3.000	PC
Code	Description	Qty	UOM																																																																														
0H2574A0	SPEED PRO DOOR PIN BRACKET	2.000	PC																																																																														
0H2689C0	SPEED.PRO CHOKE PRE SET	1.000	PC																																																																														
0H2918A0	SPEED PRO HINGE TIE ROD WITH WASHERS	2.000	PC																																																																														
0H4434A1	SPEED.Pro DOOR CHOKE WITH PINS	1.000	PC																																																																														
0H5265A1	SPEED.PRO DOOR FRONT PLATE	1.000	PC																																																																														
0H5269A1	SPEED.PRO DOOR GLASS WOOL PARTITION	1.000	PC																																																																														
0H5270A1	SPEED.PRO DOOR PARTITION	1.000	PC																																																																														
0H5272A1	SPEED.PRO DOOR MICROSWITC HES HOOK	2.000	PC																																																																														
CE1053B0	MM MICROFIT LED BAR POWER SUPPLY CABL	1.000	PC																																																																														
GN1432B1	GN1432B1	1.000	PC																																																																														
GN1682A0	SPEED.PRO LED GASKET	1.000	PC																																																																														
LP1055A0	SPEED PRO RGB LED BAR	1.000	PC																																																																														
TB2843A0	MW HANDLE TUBE	1.000	PC																																																																														
VI1074A0	4X16 SCREW FOR PLASTIC	14.000	PC																																																																														
VI1220A1	4,2x12 TCB SELF-TAPPIN G SCREW	1.000	PC																																																																														
VI1960A1	4.2X9.5 CROSS ZN-NI SELF-THREADI NG SCREW	18.000	PC																																																																														
VI2003A0	ANTI-ROTATIO N M5X0.8 H6 ZN NUT	20.000	PC																																																																														
VI2037A1	40X8 TORX SHEETTRACS SELF-THREAD SCREW	3.000	PC																																																																														



COMPONENT			SPARE PART																																																										
Code	Description	Image	Code	Description	Kit components																																																								
0H4434A	SPEED.Pro DOOR CHOKE WITH PINS		KDR1370A	SPEED.Pro COMPLETE DROPDOWN DOOR KIT	<table border="1"> <thead> <tr> <th>Code</th> <th>Description</th> <th>Qty</th> <th>UOM</th> </tr> </thead> <tbody> <tr> <td>VI2043A0</td> <td>5X40 ST. STEEL SCREW FOR PLASTIC</td> <td>4.000</td> <td>PC</td> </tr> <tr> <td>VM1524A0</td> <td>D 24 d 8 B 8 MW HINGE BEARING</td> <td>4.000</td> <td>PC</td> </tr> <tr> <td>VM1533A0</td> <td>SPEED.PRO DOOR FULCRUM PIN</td> <td>2.000</td> <td>PC</td> </tr> <tr> <td>VM1534A0</td> <td>SPEED.PRO DOOR HOLDER BEARING PIN</td> <td>2.000</td> <td>PC</td> </tr> <tr> <td>VM2456A0</td> <td>BAKERLUX SHOP.PRO HANDLE END</td> <td>1.000</td> <td>PC</td> </tr> <tr> <td>VM2489A0</td> <td>SP HANDLE END KIT + STYLUS KIT</td> <td>1.000</td> <td>PC</td> </tr> <tr> <td>VM2527A0</td> <td>STYLUS PEN FOR SP</td> <td>1.000</td> <td>PC</td> </tr> <tr> <td>VP1022A0</td> <td>MW DOOR LEFT UPPER CAP</td> <td>1.000</td> <td>PC</td> </tr> <tr> <td>VP1023A0</td> <td>MW DOOR RIGHT UPPER CAP</td> <td>1.000</td> <td>PC</td> </tr> <tr> <td>VP1024A0</td> <td>MW DOOR LEFT LOWER CAP</td> <td>1.000</td> <td>PC</td> </tr> <tr> <td>VP1025A0</td> <td>MW DOOR RIGHT LOWER CAP</td> <td>1.000</td> <td>PC</td> </tr> <tr> <td>VP1026A0</td> <td>MW LED COVE</td> <td>1.000</td> <td>PC</td> </tr> <tr> <td>VP1077A0</td> <td>MW HINGES BALL-BEARIN G CARRIER</td> <td>2.000</td> <td>PC</td> </tr> </tbody> </table>	Code	Description	Qty	UOM	VI2043A0	5X40 ST. STEEL SCREW FOR PLASTIC	4.000	PC	VM1524A0	D 24 d 8 B 8 MW HINGE BEARING	4.000	PC	VM1533A0	SPEED.PRO DOOR FULCRUM PIN	2.000	PC	VM1534A0	SPEED.PRO DOOR HOLDER BEARING PIN	2.000	PC	VM2456A0	BAKERLUX SHOP.PRO HANDLE END	1.000	PC	VM2489A0	SP HANDLE END KIT + STYLUS KIT	1.000	PC	VM2527A0	STYLUS PEN FOR SP	1.000	PC	VP1022A0	MW DOOR LEFT UPPER CAP	1.000	PC	VP1023A0	MW DOOR RIGHT UPPER CAP	1.000	PC	VP1024A0	MW DOOR LEFT LOWER CAP	1.000	PC	VP1025A0	MW DOOR RIGHT LOWER CAP	1.000	PC	VP1026A0	MW LED COVE	1.000	PC	VP1077A0	MW HINGES BALL-BEARIN G CARRIER	2.000	PC
					Code	Description	Qty	UOM																																																					
VI2043A0	5X40 ST. STEEL SCREW FOR PLASTIC	4.000	PC																																																										
VM1524A0	D 24 d 8 B 8 MW HINGE BEARING	4.000	PC																																																										
VM1533A0	SPEED.PRO DOOR FULCRUM PIN	2.000	PC																																																										
VM1534A0	SPEED.PRO DOOR HOLDER BEARING PIN	2.000	PC																																																										
VM2456A0	BAKERLUX SHOP.PRO HANDLE END	1.000	PC																																																										
VM2489A0	SP HANDLE END KIT + STYLUS KIT	1.000	PC																																																										
VM2527A0	STYLUS PEN FOR SP	1.000	PC																																																										
VP1022A0	MW DOOR LEFT UPPER CAP	1.000	PC																																																										
VP1023A0	MW DOOR RIGHT UPPER CAP	1.000	PC																																																										
VP1024A0	MW DOOR LEFT LOWER CAP	1.000	PC																																																										
VP1025A0	MW DOOR RIGHT LOWER CAP	1.000	PC																																																										
VP1026A0	MW LED COVE	1.000	PC																																																										
VP1077A0	MW HINGES BALL-BEARIN G CARRIER	2.000	PC																																																										
0H5269A	SPEED.PRO DOOR GLASS WOOL PARTITION		0H5269A1	SPEED.PRO DOOR GLASS WOOL PARTITION																																																									





COMPONENT			SPARE PART																																																																															
Code	Description	Image	Code	Description	Kit components																																																																													
0H5270A	SPEED.PRO DOOR PARTITION		KDR1370A	SPEED.Pro COMPLETE DROPDOWN DOOR KIT	<table border="1"> <thead> <tr> <th>Code</th> <th>Description</th> <th>Qty</th> <th>UOM</th> </tr> </thead> <tbody> <tr> <td>0H2574A0</td> <td>SPEED PRO DOOR PIN BRACKET</td> <td>2.000</td> <td>PC</td> </tr> <tr> <td>0H2689C0</td> <td>SPEED.PRO CHOKE PRE SET</td> <td>1.000</td> <td>PC</td> </tr> <tr> <td>0H2918A0</td> <td>SPEED PRO HINGE TIE ROD WITH WASHERS</td> <td>2.000</td> <td>PC</td> </tr> <tr> <td>0H4434A1</td> <td>SPEED.Pro DOOR CHOKE WITH PINS</td> <td>1.000</td> <td>PC</td> </tr> <tr> <td>0H5265A1</td> <td>SPEED.PRO DOOR FRONT PLATE</td> <td>1.000</td> <td>PC</td> </tr> <tr> <td>0H5269A1</td> <td>SPEED.PRO DOOR GLASS WOOL PARTITION</td> <td>1.000</td> <td>PC</td> </tr> <tr> <td>0H5270A1</td> <td>SPEED.PRO DOOR PARTITION</td> <td>1.000</td> <td>PC</td> </tr> <tr> <td>0H5272A1</td> <td>SPEED.PRO DOOR MICROSWITC HES HOOK</td> <td>2.000</td> <td>PC</td> </tr> <tr> <td>CE1053B0</td> <td>MM MICROFIT LED BAR POWER SUPPLY CABL</td> <td>1.000</td> <td>PC</td> </tr> <tr> <td>GN1432B1</td> <td>GN1432B1</td> <td>1.000</td> <td>PC</td> </tr> <tr> <td>GN1682A0</td> <td>SPEED.PRO LED GASKET</td> <td>1.000</td> <td>PC</td> </tr> <tr> <td>LP1055A0</td> <td>SPEED PRO RGB LED BAR</td> <td>1.000</td> <td>PC</td> </tr> <tr> <td>TB2843A0</td> <td>MW HANDLE TUBE</td> <td>1.000</td> <td>PC</td> </tr> <tr> <td>VI1074A0</td> <td>4X16 SCREW FOR PLASTIC</td> <td>14.000</td> <td>PC</td> </tr> <tr> <td>VI1220A1</td> <td>4,2x12 TCB SELF-TAPPIN G SCREW</td> <td>1.000</td> <td>PC</td> </tr> <tr> <td>VI1960A1</td> <td>4.2X9.5 CROSS ZN-NI SELF-THREADI NG SCREW</td> <td>18.000</td> <td>PC</td> </tr> <tr> <td>VI2003A0</td> <td>ANTI-ROTATIO N M5X0.8 H6 ZN NUT</td> <td>20.000</td> <td>PC</td> </tr> <tr> <td>VI2037A1</td> <td>40X8 TORX SHEETTRACS SELF-THREAD SCREW</td> <td>3.000</td> <td>PC</td> </tr> </tbody> </table>		Code	Description	Qty	UOM	0H2574A0	SPEED PRO DOOR PIN BRACKET	2.000	PC	0H2689C0	SPEED.PRO CHOKE PRE SET	1.000	PC	0H2918A0	SPEED PRO HINGE TIE ROD WITH WASHERS	2.000	PC	0H4434A1	SPEED.Pro DOOR CHOKE WITH PINS	1.000	PC	0H5265A1	SPEED.PRO DOOR FRONT PLATE	1.000	PC	0H5269A1	SPEED.PRO DOOR GLASS WOOL PARTITION	1.000	PC	0H5270A1	SPEED.PRO DOOR PARTITION	1.000	PC	0H5272A1	SPEED.PRO DOOR MICROSWITC HES HOOK	2.000	PC	CE1053B0	MM MICROFIT LED BAR POWER SUPPLY CABL	1.000	PC	GN1432B1	GN1432B1	1.000	PC	GN1682A0	SPEED.PRO LED GASKET	1.000	PC	LP1055A0	SPEED PRO RGB LED BAR	1.000	PC	TB2843A0	MW HANDLE TUBE	1.000	PC	VI1074A0	4X16 SCREW FOR PLASTIC	14.000	PC	VI1220A1	4,2x12 TCB SELF-TAPPIN G SCREW	1.000	PC	VI1960A1	4.2X9.5 CROSS ZN-NI SELF-THREADI NG SCREW	18.000	PC	VI2003A0	ANTI-ROTATIO N M5X0.8 H6 ZN NUT	20.000	PC	VI2037A1	40X8 TORX SHEETTRACS SELF-THREAD SCREW	3.000	PC
Code	Description	Qty	UOM																																																																															
0H2574A0	SPEED PRO DOOR PIN BRACKET	2.000	PC																																																																															
0H2689C0	SPEED.PRO CHOKE PRE SET	1.000	PC																																																																															
0H2918A0	SPEED PRO HINGE TIE ROD WITH WASHERS	2.000	PC																																																																															
0H4434A1	SPEED.Pro DOOR CHOKE WITH PINS	1.000	PC																																																																															
0H5265A1	SPEED.PRO DOOR FRONT PLATE	1.000	PC																																																																															
0H5269A1	SPEED.PRO DOOR GLASS WOOL PARTITION	1.000	PC																																																																															
0H5270A1	SPEED.PRO DOOR PARTITION	1.000	PC																																																																															
0H5272A1	SPEED.PRO DOOR MICROSWITC HES HOOK	2.000	PC																																																																															
CE1053B0	MM MICROFIT LED BAR POWER SUPPLY CABL	1.000	PC																																																																															
GN1432B1	GN1432B1	1.000	PC																																																																															
GN1682A0	SPEED.PRO LED GASKET	1.000	PC																																																																															
LP1055A0	SPEED PRO RGB LED BAR	1.000	PC																																																																															
TB2843A0	MW HANDLE TUBE	1.000	PC																																																																															
VI1074A0	4X16 SCREW FOR PLASTIC	14.000	PC																																																																															
VI1220A1	4,2x12 TCB SELF-TAPPIN G SCREW	1.000	PC																																																																															
VI1960A1	4.2X9.5 CROSS ZN-NI SELF-THREADI NG SCREW	18.000	PC																																																																															
VI2003A0	ANTI-ROTATIO N M5X0.8 H6 ZN NUT	20.000	PC																																																																															
VI2037A1	40X8 TORX SHEETTRACS SELF-THREAD SCREW	3.000	PC																																																																															



PLATON SERVICE
8 (800) 500-34-47
www.platonservice.com





COMPONENT			SPARE PART																																																										
Code	Description	Image	Code	Description	Kit components																																																								
0H5270A	SPEED.PRO DOOR PARTITION		KDR1370A	SPEED.Pro COMPLETE DROPDOWN DOOR KIT	<table border="1"> <thead> <tr> <th>Code</th> <th>Description</th> <th>Qty</th> <th>UOM</th> </tr> </thead> <tbody> <tr> <td>VI2043A0</td> <td>5X40 ST. STEEL SCREW FOR PLASTIC</td> <td>4.000</td> <td>PC</td> </tr> <tr> <td>VM1524A0</td> <td>D 24 d 8 B 8 MW HINGE BEARING</td> <td>4.000</td> <td>PC</td> </tr> <tr> <td>VM1533A0</td> <td>SPEED.PRO DOOR FULCRUM PIN</td> <td>2.000</td> <td>PC</td> </tr> <tr> <td>VM1534A0</td> <td>SPEED.PRO DOOR HOLDER BEARING PIN</td> <td>2.000</td> <td>PC</td> </tr> <tr> <td>VM2456A0</td> <td>BAKERLUX SHOP.PRO HANDLE END</td> <td>1.000</td> <td>PC</td> </tr> <tr> <td>VM2489A0</td> <td>SP HANDLE END KIT + STYLUS KIT</td> <td>1.000</td> <td>PC</td> </tr> <tr> <td>VM2527A0</td> <td>STYLUS PEN FOR SP</td> <td>1.000</td> <td>PC</td> </tr> <tr> <td>VP1022A0</td> <td>MW DOOR LEFT UPPER CAP</td> <td>1.000</td> <td>PC</td> </tr> <tr> <td>VP1023A0</td> <td>MW DOOR RIGHT UPPER CAP</td> <td>1.000</td> <td>PC</td> </tr> <tr> <td>VP1024A0</td> <td>MW DOOR LEFT LOWER CAP</td> <td>1.000</td> <td>PC</td> </tr> <tr> <td>VP1025A0</td> <td>MW DOOR RIGHT LOWER CAP</td> <td>1.000</td> <td>PC</td> </tr> <tr> <td>VP1026A0</td> <td>MW LED COVE</td> <td>1.000</td> <td>PC</td> </tr> <tr> <td>VP1077A0</td> <td>MW HINGES BALL-BEARIN G CARRIER</td> <td>2.000</td> <td>PC</td> </tr> </tbody> </table>	Code	Description	Qty	UOM	VI2043A0	5X40 ST. STEEL SCREW FOR PLASTIC	4.000	PC	VM1524A0	D 24 d 8 B 8 MW HINGE BEARING	4.000	PC	VM1533A0	SPEED.PRO DOOR FULCRUM PIN	2.000	PC	VM1534A0	SPEED.PRO DOOR HOLDER BEARING PIN	2.000	PC	VM2456A0	BAKERLUX SHOP.PRO HANDLE END	1.000	PC	VM2489A0	SP HANDLE END KIT + STYLUS KIT	1.000	PC	VM2527A0	STYLUS PEN FOR SP	1.000	PC	VP1022A0	MW DOOR LEFT UPPER CAP	1.000	PC	VP1023A0	MW DOOR RIGHT UPPER CAP	1.000	PC	VP1024A0	MW DOOR LEFT LOWER CAP	1.000	PC	VP1025A0	MW DOOR RIGHT LOWER CAP	1.000	PC	VP1026A0	MW LED COVE	1.000	PC	VP1077A0	MW HINGES BALL-BEARIN G CARRIER	2.000	PC
					Code	Description	Qty	UOM																																																					
					VI2043A0	5X40 ST. STEEL SCREW FOR PLASTIC	4.000	PC																																																					
					VM1524A0	D 24 d 8 B 8 MW HINGE BEARING	4.000	PC																																																					
					VM1533A0	SPEED.PRO DOOR FULCRUM PIN	2.000	PC																																																					
					VM1534A0	SPEED.PRO DOOR HOLDER BEARING PIN	2.000	PC																																																					
					VM2456A0	BAKERLUX SHOP.PRO HANDLE END	1.000	PC																																																					
					VM2489A0	SP HANDLE END KIT + STYLUS KIT	1.000	PC																																																					
					VM2527A0	STYLUS PEN FOR SP	1.000	PC																																																					
					VP1022A0	MW DOOR LEFT UPPER CAP	1.000	PC																																																					
					VP1023A0	MW DOOR RIGHT UPPER CAP	1.000	PC																																																					
					VP1024A0	MW DOOR LEFT LOWER CAP	1.000	PC																																																					
					VP1025A0	MW DOOR RIGHT LOWER CAP	1.000	PC																																																					
					VP1026A0	MW LED COVE	1.000	PC																																																					
					VP1077A0	MW HINGES BALL-BEARIN G CARRIER	2.000	PC																																																					
TB2843A	MW HANDLE TUBE		KTB2843A	SPEED.Pro DROP DOWN DOOR HANDLE TUBE KIT	<table border="1"> <thead> <tr> <th>Code</th> <th>Description</th> <th>Qty</th> <th>UOM</th> </tr> </thead> <tbody> <tr> <td>TB2843A0</td> <td>MW HANDLE TUBE</td> <td>1.000</td> <td>PC</td> </tr> <tr> <td>VI2043A0</td> <td>5X40 ST. STEEL SCREW FOR PLASTIC</td> <td>4.000</td> <td>PC</td> </tr> <tr> <td>VM2456A0</td> <td>BAKERLUX SHOP.PRO HANDLE END</td> <td>1.000</td> <td>PC</td> </tr> <tr> <td>VM2489A0</td> <td>SP HANDLE END KIT + STYLUS KIT</td> <td>1.000</td> <td>PC</td> </tr> <tr> <td>VM2527A0</td> <td>STYLUS PEN FOR SP</td> <td>1.000</td> <td>PC</td> </tr> </tbody> </table>	Code	Description	Qty	UOM	TB2843A0	MW HANDLE TUBE	1.000	PC	VI2043A0	5X40 ST. STEEL SCREW FOR PLASTIC	4.000	PC	VM2456A0	BAKERLUX SHOP.PRO HANDLE END	1.000	PC	VM2489A0	SP HANDLE END KIT + STYLUS KIT	1.000	PC	VM2527A0	STYLUS PEN FOR SP	1.000	PC																																
					Code	Description	Qty	UOM																																																					
					TB2843A0	MW HANDLE TUBE	1.000	PC																																																					
					VI2043A0	5X40 ST. STEEL SCREW FOR PLASTIC	4.000	PC																																																					
					VM2456A0	BAKERLUX SHOP.PRO HANDLE END	1.000	PC																																																					
VM2489A0	SP HANDLE END KIT + STYLUS KIT	1.000	PC																																																										
VM2527A0	STYLUS PEN FOR SP	1.000	PC																																																										



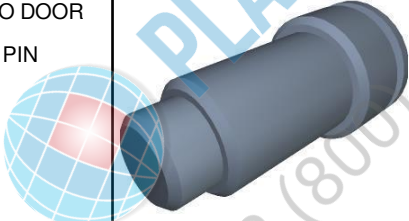

COMPONENT			SPARE PART																						
Code	Description	Image	Code	Description	Kit components																				
VM2456A	BAKERLUX SHOP.PRO HANDLE END		KVM2456A	2 PCS BAKERLUX SHOP.PRO HANDLE END KIT	<table border="1"> <thead> <tr> <th>Code</th> <th>Description</th> <th>Qty</th> <th>UOM</th> </tr> </thead> <tbody> <tr> <td>VI1147A0</td> <td>5X25 STAINLESS STEEL SCREW</td> <td>4.000</td> <td>PC</td> </tr> <tr> <td>VM2456A0</td> <td>BAKERLUX SHOP.PRO HANDLE END</td> <td>1.000</td> <td>PC</td> </tr> <tr> <td>VM2489A0</td> <td>SP HANDLE END KIT + STYLUS KIT</td> <td>1.000</td> <td>PC</td> </tr> <tr> <td>VM2527A0</td> <td>STYLUS PEN FOR SP</td> <td>1.000</td> <td>PC</td> </tr> </tbody> </table>	Code	Description	Qty	UOM	VI1147A0	5X25 STAINLESS STEEL SCREW	4.000	PC	VM2456A0	BAKERLUX SHOP.PRO HANDLE END	1.000	PC	VM2489A0	SP HANDLE END KIT + STYLUS KIT	1.000	PC	VM2527A0	STYLUS PEN FOR SP	1.000	PC
Code	Description	Qty	UOM																						
VI1147A0	5X25 STAINLESS STEEL SCREW	4.000	PC																						
VM2456A0	BAKERLUX SHOP.PRO HANDLE END	1.000	PC																						
VM2489A0	SP HANDLE END KIT + STYLUS KIT	1.000	PC																						
VM2527A0	STYLUS PEN FOR SP	1.000	PC																						
VM2527A	STYLUS PEN FOR S		KVM2527A	EVEREO-BLSP TOUCH STYLUS 5 PCS KIT	<table border="1"> <thead> <tr> <th>Code</th> <th>Description</th> <th>Qty</th> <th>UOM</th> </tr> </thead> <tbody> <tr> <td>VM2527A0</td> <td>STYLUS PEN FOR SP</td> <td>5.000</td> <td>PC</td> </tr> </tbody> </table>	Code	Description	Qty	UOM	VM2527A0	STYLUS PEN FOR SP	5.000	PC												
Code	Description	Qty	UOM																						
VM2527A0	STYLUS PEN FOR SP	5.000	PC																						
PE2153A	SP DUO CONTROL BOARD		KPE2153A	SPEED.PRO CONTROL BOARD KIT	<table border="1"> <thead> <tr> <th>Code</th> <th>Description</th> <th>Qty</th> <th>UOM</th> </tr> </thead> <tbody> <tr> <td>PE2153A0</td> <td>SP DUO CONTROL BOARD</td> <td>1.000</td> <td>PC</td> </tr> <tr> <td>VI1147A0</td> <td>5X25 STAINLESS STEEL SCREW</td> <td>2.000</td> <td>PC</td> </tr> </tbody> </table>	Code	Description	Qty	UOM	PE2153A0	SP DUO CONTROL BOARD	1.000	PC	VI1147A0	5X25 STAINLESS STEEL SCREW	2.000	PC								
Code	Description	Qty	UOM																						
PE2153A0	SP DUO CONTROL BOARD	1.000	PC																						
VI1147A0	5X25 STAINLESS STEEL SCREW	2.000	PC																						
VI1930A	ST. STEEL 5X20 CHIP SCREW		VI1147A0	5X25 STAINLESS STEEL SCREW																					
VN1179A	CONTROL BOARD 40x40x20mm 12V COOLING FAN		KVN1179A	CONTROL BOARD COOLING FAN KIT	<table border="1"> <thead> <tr> <th>Code</th> <th>Description</th> <th>Qty</th> <th>UOM</th> </tr> </thead> <tbody> <tr> <td>VN1179A1</td> <td>CONTROL BOARD 40x40x20mm 12V COOLING FAN</td> <td>1.000</td> <td>PC</td> </tr> </tbody> </table>	Code	Description	Qty	UOM	VN1179A1	CONTROL BOARD 40x40x20mm 12V COOLING FAN	1.000	PC												
Code	Description	Qty	UOM																						
VN1179A1	CONTROL BOARD 40x40x20mm 12V COOLING FAN	1.000	PC																						

COMPONENT			SPARE PART										
Code	Description	Image	Code	Description	Kit components								
VP1030A	SPEED.PRO CONTROL BOARD SPACER		KVP1030A	SPEED.PRO CONTROL BOARD SPACER KIT	<table border="1"> <thead> <tr> <th>Code</th> <th>Description</th> <th>Qty</th> <th>UOM</th> </tr> </thead> <tbody> <tr> <td>VP1030A0</td> <td>SPEED.PRO CONTROL BOARD SPACE</td> <td>1.000</td> <td>PC</td> </tr> </tbody> </table>	Code	Description	Qty	UOM	VP1030A0	SPEED.PRO CONTROL BOARD SPACE	1.000	PC
Code	Description	Qty	UOM										
VP1030A0	SPEED.PRO CONTROL BOARD SPACE	1.000	PC										
VP1031A	MW FAN CARRIER		KVP1031A	SPEED.PRO COOLING FAN HOLDER KIT	<table border="1"> <thead> <tr> <th>Code</th> <th>Description</th> <th>Qty</th> <th>UOM</th> </tr> </thead> <tbody> <tr> <td>VP1031A0</td> <td>MW FAN CARRIER</td> <td>1.000</td> <td>PC</td> </tr> </tbody> </table>	Code	Description	Qty	UOM	VP1031A0	MW FAN CARRIER	1.000	PC
Code	Description	Qty	UOM										
VP1031A0	MW FAN CARRIER	1.000	PC										
0H2918A	SPEED PRO HINGE TIE ROD WITH WASHERS		0H2918A0	SPEED PRO HINGE TIE ROD WITH WASHERS									
VM1524A	D 24 d 8 B 8 MW HINGE BEARING		VM1524A0	D 24 d 8 B 8 MW HINGE BEARING									
VM1534A	SPEED.PRO DOOR HOLDER BEARING PIN		VM1534A0	SPEED.PRO DOOR HOLDER BEARING PIN									

COMPONENT			SPARE PART										
Code	Description	Image	Code	Description	Kit components								
VP1077A	MW HINGES BALL-BEARING CARRIER		KVP1077A	SPEED.Pro HINGES BEARING HOLDER KIT	<table border="1"> <thead> <tr> <th>Code</th> <th>Description</th> <th>Qty</th> <th>UOM</th> </tr> </thead> <tbody> <tr> <td>VP1077A0</td> <td>MW HINGES BALL-BEARIN G CARRIER</td> <td>1.000</td> <td>PC</td> </tr> </tbody> </table>	Code	Description	Qty	UOM	VP1077A0	MW HINGES BALL-BEARIN G CARRIER	1.000	PC
Code	Description	Qty	UOM										
VP1077A0	MW HINGES BALL-BEARIN G CARRIER	1.000	PC										
0H2918A	SPEED PRO HINGE TIE ROD WITH WASHERS		0H2918A0	SPEED PRO HINGE TIE ROD WITH WASHERS									
VM1524A	D 24 d 8 B 8 MW HINGE BEARING		VM1524A0	D 24 d 8 B 8 MW HINGE BEARING									
VM1534A	SPEED.PRO DOOR HOLDER BEARING PIN		VM1534A0	SPEED.PRO DOOR HOLDER BEARING PIN									
VP1077A	MW HINGES BALL-BEARING CARRIER		KVP1077A	SPEED.Pro HINGES BEARING HOLDER KIT	<table border="1"> <thead> <tr> <th>Code</th> <th>Description</th> <th>Qty</th> <th>UOM</th> </tr> </thead> <tbody> <tr> <td>VP1077A0</td> <td>MW HINGES BALL-BEARIN G CARRIER</td> <td>1.000</td> <td>PC</td> </tr> </tbody> </table>	Code	Description	Qty	UOM	VP1077A0	MW HINGES BALL-BEARIN G CARRIER	1.000	PC
Code	Description	Qty	UOM										
VP1077A0	MW HINGES BALL-BEARIN G CARRIER	1.000	PC										

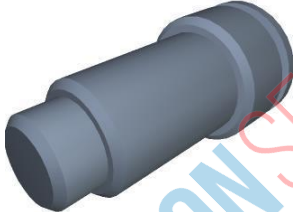

COMPONENT			SPARE PART																		
Code	Description	Image	Code	Description	Kit components																
0H2574A	SPEED PRO DOOR PIN BRACKET		K0H2574A	SPEED.Pro DOOR LOWER HINGE KIT	<table border="1"> <thead> <tr> <th>Code</th> <th>Description</th> <th>Qty</th> <th>UOM</th> </tr> </thead> <tbody> <tr> <td>0H2574A0</td> <td>SPEED PRO DOOR PIN BRACKET</td> <td>1.000</td> <td>PC</td> </tr> <tr> <td>VM1524A0</td> <td>D 24 d 8 B 8 MW HINGE BEARING</td> <td>1.000</td> <td>PC</td> </tr> <tr> <td>VM1533A0</td> <td>SPEED.PRO DOOR DOOR FULCRUM PIN</td> <td>1.000</td> <td>PC</td> </tr> </tbody> </table>	Code	Description	Qty	UOM	0H2574A0	SPEED PRO DOOR PIN BRACKET	1.000	PC	VM1524A0	D 24 d 8 B 8 MW HINGE BEARING	1.000	PC	VM1533A0	SPEED.PRO DOOR DOOR FULCRUM PIN	1.000	PC
Code	Description	Qty	UOM																		
0H2574A0	SPEED PRO DOOR PIN BRACKET	1.000	PC																		
VM1524A0	D 24 d 8 B 8 MW HINGE BEARING	1.000	PC																		
VM1533A0	SPEED.PRO DOOR DOOR FULCRUM PIN	1.000	PC																		
VM1524A	D 24 d 8 B 8 MW HINGE BEARING		VM1524A0	D 24 d 8 B 8 MW HINGE BEARING																	
VM1533A	SPEED.PRO DOOR FULCRUM PIN		VM1533A0	SPEED.PRO DOOR FULCRUM PIN																	
VP1024A	MW DOOR LEFT LOWER CAP		KVP1024A	SPEED.Pro DOOR LEFT LOWER CAP KI	<table border="1"> <thead> <tr> <th>Code</th> <th>Description</th> <th>Qty</th> <th>UOM</th> </tr> </thead> <tbody> <tr> <td>VP1024A0</td> <td>MW DOOR LEFT LOWER CAP</td> <td>1.000</td> <td>PC</td> </tr> </tbody> </table>	Code	Description	Qty	UOM	VP1024A0	MW DOOR LEFT LOWER CAP	1.000	PC								
Code	Description	Qty	UOM																		
VP1024A0	MW DOOR LEFT LOWER CAP	1.000	PC																		
0H2574A	SPEED PRO DOOR PIN BRACKET		K0H2574A	SPEED.Pro DOOR LOWER HINGE KIT	<table border="1"> <thead> <tr> <th>Code</th> <th>Description</th> <th>Qty</th> <th>UOM</th> </tr> </thead> <tbody> <tr> <td>0H2574A0</td> <td>SPEED PRO DOOR PIN BRACKET</td> <td>1.000</td> <td>PC</td> </tr> <tr> <td>VM1524A0</td> <td>D 24 d 8 B 8 MW HINGE BEARING</td> <td>1.000</td> <td>PC</td> </tr> <tr> <td>VM1533A0</td> <td>SPEED.PRO DOOR DOOR FULCRUM PIN</td> <td>1.000</td> <td>PC</td> </tr> </tbody> </table>	Code	Description	Qty	UOM	0H2574A0	SPEED PRO DOOR PIN BRACKET	1.000	PC	VM1524A0	D 24 d 8 B 8 MW HINGE BEARING	1.000	PC	VM1533A0	SPEED.PRO DOOR DOOR FULCRUM PIN	1.000	PC
Code	Description	Qty	UOM																		
0H2574A0	SPEED PRO DOOR PIN BRACKET	1.000	PC																		
VM1524A0	D 24 d 8 B 8 MW HINGE BEARING	1.000	PC																		
VM1533A0	SPEED.PRO DOOR DOOR FULCRUM PIN	1.000	PC																		

COMPONENT			SPARE PART																						
Code	Description	Image	Code	Description	Kit components																				
VM1524A	D 24 d 8 B 8 MW HINGE BEARING		VM1524A0	D 24 d 8 B 8 MW HINGE BEARING																					
VM1533A	SPEED.PRO DOOR FULCRUM PIN		VM1533A0	SPEED.PRO DOOR FULCRUM PIN																					
VP1025A	MW DOOR RIGHT LOWER CAP		KVP1025A	SPEED.Pro DOOR RIGHT LOWER CAP KIT	<table border="1"> <thead> <tr> <th>Code</th> <th>Description</th> <th>Qty</th> <th>UOM</th> </tr> </thead> <tbody> <tr> <td>VP1025A0</td> <td>MW DOOR RIGHT LOWER CAP</td> <td>1.000</td> <td>PC</td> </tr> </tbody> </table>	Code	Description	Qty	UOM	VP1025A0	MW DOOR RIGHT LOWER CAP	1.000	PC												
Code	Description	Qty	UOM																						
VP1025A0	MW DOOR RIGHT LOWER CAP	1.000	PC																						
CE1053B	MM MICROFIT LED BAR POWER SUPPLY CABLE		KCE1053B	LED BAR EXTENSION CABLE KIT	<table border="1"> <thead> <tr> <th>Code</th> <th>Description</th> <th>Qty</th> <th>UOM</th> </tr> </thead> <tbody> <tr> <td>CE1053B0</td> <td>MM MICROFIT LED BAR POWER SUPPLY CABL</td> <td>1.000</td> <td>PC</td> </tr> </tbody> </table>	Code	Description	Qty	UOM	CE1053B0	MM MICROFIT LED BAR POWER SUPPLY CABL	1.000	PC												
Code	Description	Qty	UOM																						
CE1053B0	MM MICROFIT LED BAR POWER SUPPLY CABL	1.000	PC																						
GN1682A	SPEED.PRO LED GASKET		KLP1055A	SPEED PRO RGB LED BAR KIT	<table border="1"> <thead> <tr> <th>Code</th> <th>Description</th> <th>Qty</th> <th>UOM</th> </tr> </thead> <tbody> <tr> <td>CE1053B0</td> <td>MM MICROFIT LED BAR POWER SUPPLY CABL</td> <td>1.000</td> <td>PC</td> </tr> <tr> <td>GN1682A0</td> <td>SPEED.PRO LED GASKET</td> <td>1.000</td> <td>PC</td> </tr> <tr> <td>LP1055A0</td> <td>SPEED PRO RGB LED BAR</td> <td>1.000</td> <td>PC</td> </tr> <tr> <td>VP1026A0</td> <td>MW LED COVE</td> <td>1.000</td> <td>PC</td> </tr> </tbody> </table>	Code	Description	Qty	UOM	CE1053B0	MM MICROFIT LED BAR POWER SUPPLY CABL	1.000	PC	GN1682A0	SPEED.PRO LED GASKET	1.000	PC	LP1055A0	SPEED PRO RGB LED BAR	1.000	PC	VP1026A0	MW LED COVE	1.000	PC
Code	Description	Qty	UOM																						
CE1053B0	MM MICROFIT LED BAR POWER SUPPLY CABL	1.000	PC																						
GN1682A0	SPEED.PRO LED GASKET	1.000	PC																						
LP1055A0	SPEED PRO RGB LED BAR	1.000	PC																						
VP1026A0	MW LED COVE	1.000	PC																						

COMPONENT			SPARE PART																						
Code	Description	Image	Code	Description	Kit components																				
LP1055A	SPEED PRO RGB LED BAR		KLP1055A	SPEED PRO RGB LED BAR KIT	<table border="1"> <thead> <tr> <th>Code</th> <th>Description</th> <th>Qty</th> <th>UOM</th> </tr> </thead> <tbody> <tr> <td>CE1053B0</td> <td>MM MICROFIT LED BAR POWER SUPPLY CABL</td> <td>1.000</td> <td>PC</td> </tr> <tr> <td>GN1682A0</td> <td>SPEED.PRO LED GASKET</td> <td>1.000</td> <td>PC</td> </tr> <tr> <td>LP1055A0</td> <td>SPEED PRO RGB LED BAR</td> <td>1.000</td> <td>PC</td> </tr> <tr> <td>VP1026A0</td> <td>MW LED COVE</td> <td>1.000</td> <td>PC</td> </tr> </tbody> </table>	Code	Description	Qty	UOM	CE1053B0	MM MICROFIT LED BAR POWER SUPPLY CABL	1.000	PC	GN1682A0	SPEED.PRO LED GASKET	1.000	PC	LP1055A0	SPEED PRO RGB LED BAR	1.000	PC	VP1026A0	MW LED COVE	1.000	PC
			Code	Description	Qty	UOM																			
CE1053B0	MM MICROFIT LED BAR POWER SUPPLY CABL	1.000	PC																						
GN1682A0	SPEED.PRO LED GASKET	1.000	PC																						
LP1055A0	SPEED PRO RGB LED BAR	1.000	PC																						
VP1026A0	MW LED COVE	1.000	PC																						
KLP0055A	HOT VACUUM RGB LED BAR KIT	<table border="1"> <thead> <tr> <th>Code</th> <th>Description</th> <th>Qty</th> <th>UOM</th> </tr> </thead> <tbody> <tr> <td>CE1053B0</td> <td>MM MICROFIT LED BAR POWER SUPPLY CABL</td> <td>1.000</td> <td>PC</td> </tr> <tr> <td>LP1055A0</td> <td>SPEED PRO RGB LED BAR</td> <td>1.000</td> <td>PC</td> </tr> <tr> <td>VP1196A0</td> <td></td> <td>1.000</td> <td>PC</td> </tr> </tbody> </table>	Code	Description	Qty	UOM	CE1053B0	MM MICROFIT LED BAR POWER SUPPLY CABL	1.000	PC	LP1055A0	SPEED PRO RGB LED BAR	1.000	PC	VP1196A0		1.000	PC							
Code	Description	Qty	UOM																						
CE1053B0	MM MICROFIT LED BAR POWER SUPPLY CABL	1.000	PC																						
LP1055A0	SPEED PRO RGB LED BAR	1.000	PC																						
VP1196A0		1.000	PC																						
VP1022A	MW DOOR LEFT UPPER CAP		KVP1022A	SPEED.PRO LEFT DOOR UPPER CAP KIT	<table border="1"> <thead> <tr> <th>Code</th> <th>Description</th> <th>Qty</th> <th>UOM</th> </tr> </thead> <tbody> <tr> <td>VP1022A0</td> <td>MW DOOR LEFT UPPER CAP</td> <td>1.000</td> <td>PC</td> </tr> </tbody> </table>	Code	Description	Qty	UOM	VP1022A0	MW DOOR LEFT UPPER CAP	1.000	PC												
Code	Description	Qty	UOM																						
VP1022A0	MW DOOR LEFT UPPER CAP	1.000	PC																						
VP1026A	MW LED COVER		VP1026A0	MW LED COVER																					
CE1065A	4x0.5 MICROFIT WIRE 4P-500mm-MICROFIT4P		KCE1065A	4P-500mm MICROFIT CABLE KI	<table border="1"> <thead> <tr> <th>Code</th> <th>Description</th> <th>Qty</th> <th>UOM</th> </tr> </thead> <tbody> <tr> <td>CE1065A0</td> <td>4x0.5 MICROFIT WIRE 4P-500mm-MICROFIT4P</td> <td>1.000</td> <td>PC</td> </tr> </tbody> </table>	Code	Description	Qty	UOM	CE1065A0	4x0.5 MICROFIT WIRE 4P-500mm-MICROFIT4P	1.000	PC												
Code	Description	Qty	UOM																						
CE1065A0	4x0.5 MICROFIT WIRE 4P-500mm-MICROFIT4P	1.000	PC																						



COMPONENT			SPARE PART										
Code	Description	Image	Code	Description	Kit components								
CE1285A	EMI ROUND FERRITE MOD.2643801502		OUTOFPRODUCTIO	ITEM OUT OF PRODUCTION									
GN1432B	GN1432B1		KGN1432B	MW DOOR SEAL	<table border="1"> <thead> <tr> <th>Code</th> <th>Description</th> <th>Qty</th> <th>UOM</th> </tr> </thead> <tbody> <tr> <td>GN1432B1</td> <td>GN1432B1</td> <td>1.000</td> <td>PC</td> </tr> </tbody> </table>	Code	Description	Qty	UOM	GN1432B1	GN1432B1	1.000	PC
Code	Description	Qty	UOM										
GN1432B1	GN1432B1	1.000	PC										
VI1074A	4X16 SCREW FOR PLASTIC		VI1074A0	4X16 SCREW FOR PLASTIC									
VI2043A	5X40 ST. STEEL SCREW FOR PLASTI		VI2043A0	5X40 ST. STEEL SCREW FOR PLASTI									
VP1023A	MW DOOR RIGHT UPPER CAP		KVP1023A	SPEED.PRO RIGHT DOOR UPPER CAP KIT	<table border="1"> <thead> <tr> <th>Code</th> <th>Description</th> <th>Qty</th> <th>UOM</th> </tr> </thead> <tbody> <tr> <td>VP1023A0</td> <td>MW DOOR RIGHT UPPER CAP</td> <td>1.000</td> <td>PC</td> </tr> </tbody> </table>	Code	Description	Qty	UOM	VP1023A0	MW DOOR RIGHT UPPER CAP	1.000	PC
Code	Description	Qty	UOM										
VP1023A0	MW DOOR RIGHT UPPER CAP	1.000	PC										